



# product / price list

## DISCOUNT SCHEDULE FOR ALL SNAP-ACTION SWITCHES

Quantity	Discount	Multiplier
1 to 49	List	1.00
50 to 99	27%	0.73
100 to 499	37%	0.63
500 to 999	43%	0.57
1000 to 1999	48%	0.52
2000 to 4999	54%	0.46

For quantities of 5000 and over consult factory

### NOTES (apply to all products in this product/price list)

1. Cash Terms— $\frac{1}{2}\%$  10 days, net 30 days.
2. Shipments—F.O.B. Shipping Point, Waukegan, Ill.
3. Prices and Discounts—Are subject to change without notice.
4. Multiplier—Net Price can be determined by multiplying list price and multiplier shown in discount schedule.
5. Discounts—Are offered on basis of volume production. To warrant discount each shipment must consist of 2000 pieces minimum, or complete order if less than 2000 pieces.

## GENERAL PURPOSE - SINGLE POLE E13 SERIES/E14

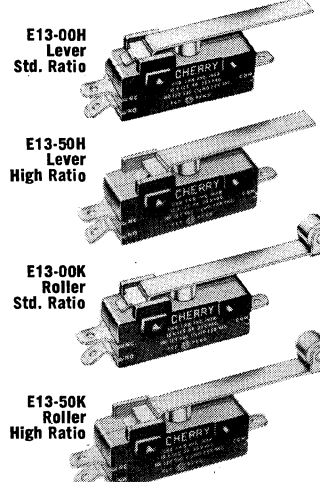
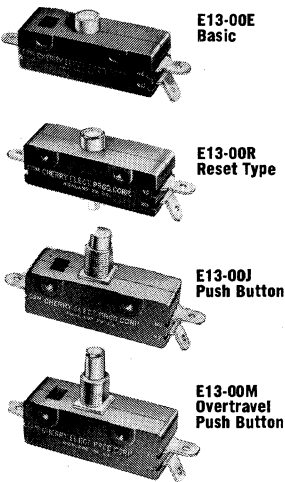

**E13 SERIES — 15 AMPS., 125-250 VAC,  $\frac{3}{4}$  H.P., 125 VAC —  $1\frac{1}{2}$  H.P., 250 VAC**  
**E14 SERIES — 25 AMPS., 125-250 VAC, 1 H.P., 125 VAC — 2 H.P., 250 VAC**

SWITCH BODY —  $1\frac{13}{16}'' \times \frac{1}{4}'' \times \frac{1}{4}''$

Part No.	Circuitry	List Price	Part No.	Circuitry	List Price
E13-00E	SPDT	\$0.75	E13-50K	SPDT	\$1.36
E13-01E	SPST NO	.72	E13-51K	SPST NO	1.33
E13-02E	SPST NC	.72	E13-52K	SPST NC	1.33
E13-00R	SPDT	1.67	E14-00A	SPDT	1.04
E13-01R	SPST NO	1.64	E14-01A	SPST NO	1.01
E13-02R	SPST NC	1.64	E14-02A	SPST NC	1.01
E13-00J	SPDT	.85	E14-00H	SPDT	1.37
E13-01J	SPST NO	.82	E14-01H	SPST NO	1.34
E13-02J	SPST NC	.82	E14-02H	SPST NC	1.34
E13-00M	SPDT	1.04	E14-50H	SPDT	1.37
E13-01M	SPST NO	1.01	E14-51H	SPST NO	1.34
E13-02M	SPST NC	1.01	E14-52H	SPST NC	1.34
E13-00H	SPDT	1.08	E14-00K	SPDT	1.65
E13-01H	SPST NO	1.05	E14-01K	SPST NO	1.62
E13-02H	SPST NC	1.05	E14-02K	SPST NC	1.62
E13-50H	SPDT	1.08	E14-50K	SPDT	1.65
E13-51H	SPST NO	1.05	E14-51K	SPST NO	1.62
E13-52H	SPST NC	1.05	E14-52K	SPST NC	1.62
E13-00K	SPDT	1.36			
E13-01K	SPST NO	1.33			
E13-02K	SPST NC	1.33			

A rugged switch with large overtravel, wear resistant nylon button, many integral hinged actuator variations, and choice of two electrical ratings.

## GENERAL PURPOSE - DOUBLE POLE E19 SERIES/E20

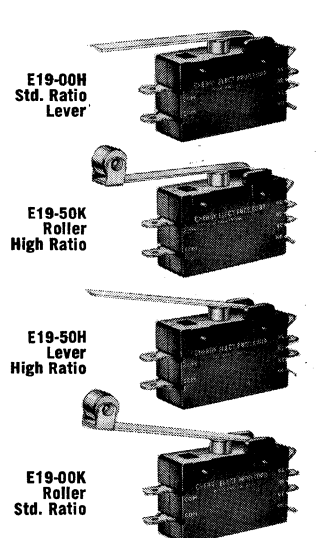
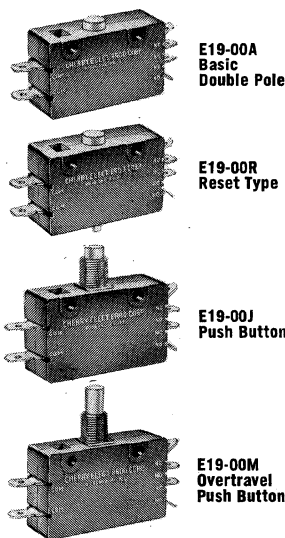

**E19 SERIES — 15 AMPS., 125-250 VAC,  $\frac{3}{4}$  H.P., 125 VAC —  $1\frac{1}{2}$  H.P., 250 VAC**  
**E20 SERIES — 20 AMPS., 125-250 VAC, 1 H.P., 125 VAC — 2 H.P., 250 VAC**

SWITCH BODY —  $1\frac{13}{16}'' \times 1\frac{1}{8}'' \times \frac{1}{4}''$

Part No.	Circuitry	List Price	Part No.	Circuitry	List Price
E19-00A	DPDT	\$1.80	E19-00M	DPDT	\$2.10
E19-01A	DPST NO	1.75	E19-01M	DPST NO	2.05
E19-02A	DPST NC	1.75	E19-02M	DPST NC	2.05
E19-00R	DPDT	2.64	E20-00A	DPDT	2.67
E19-01R	DPST NO	2.59	E20-01A	DPST NO	2.62
E19-02R	DPST NC	2.59	E20-02A	DPST NC	2.62
E19-00H	DPDT	2.00	E20-00H	DPDT	2.87
E19-01H	DPST NO	1.95	E20-01H	DPST NO	2.82
E19-02H	DPST NC	1.95	E20-02H	DPST NC	2.82
E19-50H	DPDT	2.00	E20-50H	DPDT	2.87
E19-51H	DPST NO	1.95	E20-51H	DPST NO	2.82
E19-52H	DPST NC	1.95	E20-52H	DPST NC	2.82
E19-00K	DPDT	2.13	E20-00K	DPDT	3.00
E19-01K	DPST NO	2.08	E20-01K	DPST NO	2.95
E19-02K	DPST NC	2.08	E20-02K	DPST NC	2.95
E19-50K	DPDT	2.13	E20-50K	DPDT	3.00
E19-51K	DPST NO	2.08	E20-51K	DPST NO	2.95
E19-52K	DPST NC	2.08	E20-52K	DPST NC	2.95
E19-00J	DPDT	1.90	E20-00J	DPDT	2.77
E19-01J	DPST NO	1.85	E20-01J	DPST NO	2.72
E19-02J	DPST NC	1.85	E20-02J	DPST NC	2.72

A compact switch with double pole electrical control, large overtravel, sturdy construction and wide range of actuators in two electrical ratings.

### CHERRY ELECTRICAL PRODUCTS CORPORATION

3600 SUNSET AVENUE / WAUKEGAN, ILLINOIS 60085 / (312) 689-7703 / TWX (910) 235-1572 / CABLE: CHERRY, WAUKEGAN  
 FOR CURRENT SOURCE DATA CALL TOLL-FREE 800-645-9200 (IN N. Y. STATE CALL COLLECT (516) 294-0990)



**PANEL MOUNT PUSHBUTTON - SINGLE POLE/E69 SERIES**

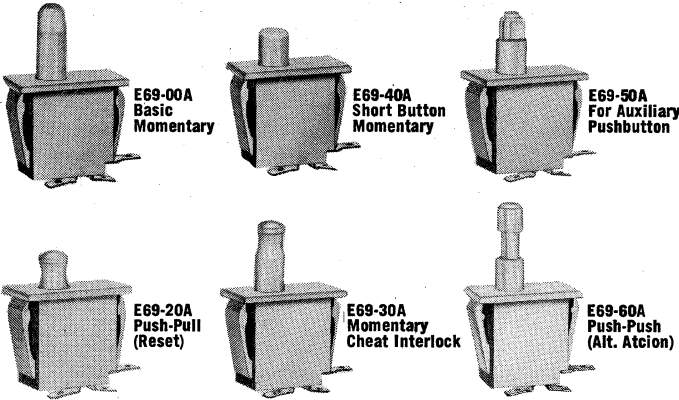

**ELECTRICAL RATING: 10 AMP., 1/3 H.P. 125/250 VAC**  
**SWITCH BODY — 1 1/4" x 1" x 1 1/8"**

Exclusive stainless steel coil spring, long-life mechanism. Snap-in mounting in choice of momentary contact action, push-pull (reset), momentary "cheat" interlock, push-push (alternate action).

Part No.	Circuitry	List Price	Part No.	Circuitry	List Price
E69-00A	SPDT	\$0.95	E69-40A	SPDT	\$1.00
E69-01A	SPST NO	.95	E69-41A	SPST NO	1.00
E69-02A	SPST NC	.95	E69-42A	SPST NC	1.00
E69-20A	SPDT	.92	E69-50A	SPDT	.95
E69-21A	SPST NO	.92	E69-51A	SPST NO	.95
E69-22A	SPST NC	.92	E69-52A	SPST NC	.95
E69-30A	SPDT	1.25	E69-60A	SPDT	2.20
E69-31A	SPST NO	1.25	E69-61A	SPST NO	2.20
E69-32A	SPST NC	1.25	E69-62A	SPST NC	2.20

**PANEL MOUNT PUSHBUTTON - DOUBLE POLE/E79 SERIES**

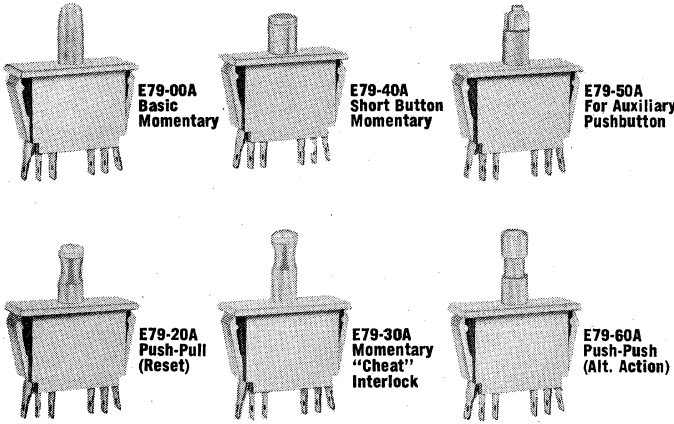

**ELECTRICAL RATING — 10 AMP., 125/250 VAC 1/3 H.P., 125/250 VAC**

**SWITCH BODY — 1 1/2" x 1" x 1 1/8"**

Two circuit controls from a single actuator is contained in this snap-in panel mount switch. White nylon switch case, rock-wipe contact action, large overtravel, white acetal actuating button and long-life coil spring mechanism.

Part No.	Circuitry	List Price	Part No.	Circuitry	List Price
E79-00A	DPDT	\$1.55	E79-40A	DPDT	\$1.60
E79-01A	DPST NO	1.55	E79-41A	DPST NO	1.60
E79-02A	DPST NC	1.55	E79-42A	DPST NC	1.60
E79-20A	DPDT	1.52	E79-50A	DPDT	1.55
E79-21A	DPST NO	1.52	E79-51A	DPST NO	1.55
E79-22A	DPST NC	1.52	E79-52A	DPST NC	1.55
E79-30A	DPDT	2.25	E79-60A	DPDT	2.80
E79-31A	DPST NO	2.25	E79-61A	DPST NO	2.80
E79-32A	DPST NC	2.25	E79-62A	DPST NC	2.80

**LOW TORQUE/E51 SERIES**

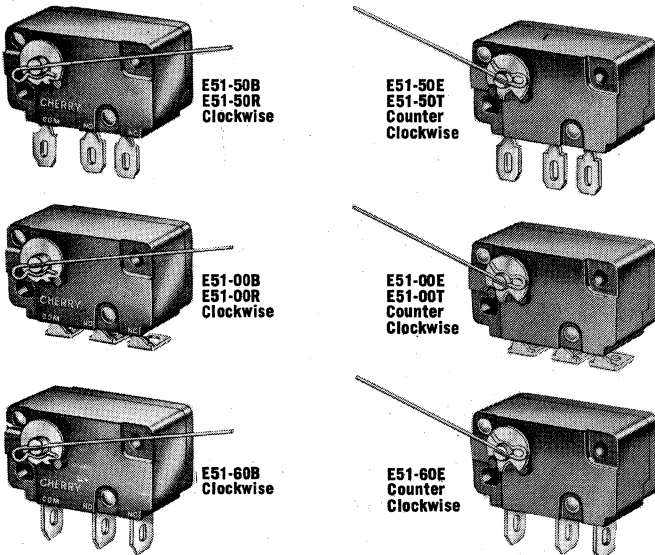

**ELECTRICAL RATING — 5 AMP., 125/250 VAC 1/3 H.P. 125/250 VAC**

**SWITCH BODY — 1 1/2" x 1" x 1 1/8"**

Rotary action, coin switch with sensitive feather light operation. Same coil spring, long-life Cherry mechanism. Available in clockwise or counter clockwise actuation and a wide choice of terminal configurations.

Part No.	Circuitry	List Price	Part No.	Circuitry	List Price
E51-00B	SPDT	\$2.12	E51-50E	SPDT	\$2.12
E51-01B	SPST NO	2.12	E51-51E	SPST NO	2.12
E51-02B	SPST NC	2.12	E51-52E	SPST NC	2.12
E51-00E	SPDT	2.12	E51-50R	SPDT	2.12
E51-01E	SPST NO	2.12	E51-51R	SPST NO	2.12
E51-02E	SPST NC	2.12	E51-52R	SPST NC	2.12
E51-00R	SPDT	2.12	E51-50T	SPDT	2.12
E51-01R	SPST NO	2.12	E51-51T	SPST NO	2.12
E51-02R	SPST NC	2.12	E51-52T	SPST NC	2.12
E51-00T	SPDT	2.12	E51-60B	SPDT	2.12
E51-01T	SPST NO	2.12	E51-61B	SPST NO	2.12
E51-02T	SPST NC	2.12	E51-62B	SPST NC	2.12
E51-50B	SPDT	2.12	E51-60E	SPDT	2.12
E51-51B	SPST NO	2.12	E51-61E	SPST NO	2.12
E51-52B	SPST NC	2.12	E51-62E	SPST NC	2.12

**CHERRY ELECTRICAL PRODUCTS CORPORATION**  
 3600 SUNSET AVENUE / WAUKEGAN, ILLINOIS 60085 / (312) 689-7703 / TWX (910) 235-1572 / CABLE: CHERRY, WAUKEGAN  
 FOR CURRENT SOURCE DATA CALL TOLL-FREE 800-645-9200 (IN N. Y. STATE CALL COLLECT (516) 294-0990)



**SUBMINIATURE SERIES E61-LIGHT FORCE/SERIES E62-STANDARD FORCE**

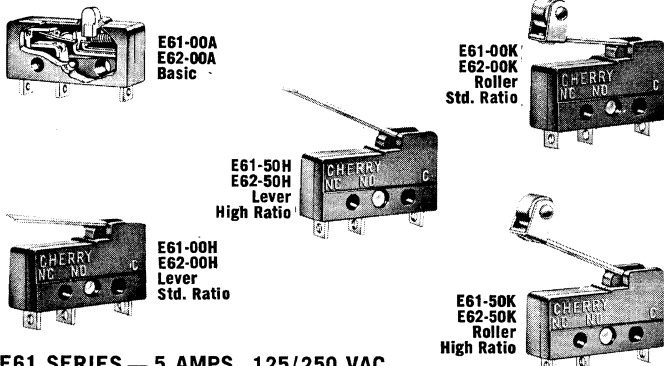

**E61 SERIES — 5 AMPS., 125/250 VAC**  
**SWITCH BODY — 25/32" x 23/64" x 1/4"**  
**E62 SERIES — 10.1 AMPS., 125/250 VAC., 1/4 H.P., 125 VAC**  
**SWITCH BODY — 25/32" x 23/64" x 1/4"**  
 A switch with large overtravel, integral hinged actuators, and choice of .093" QC, .110" QC, or solder terminals with two force and rating ranges.

Part No.	Circuitry	Terminal	List Price	Part No.	Circuitry	Terminal	List Price
E61-00A	SPDT	QC .093"	\$1.22	E61-30K	SPDT	.110" QC	\$1.50
E61-01A	SPST NO	QC .093"	1.22	E61-31K	SPST NO	.110" QC	1.50
E61-02A	SPST NC	QC .093"	1.22	E61-32K	SPSA NC	.110" QC	1.50
E61-00H	SPDT	QC .093"	1.32	E61-50H	SPDT	QC .093"	1.32
E61-01H	SPST NO	QC .093"	1.32	E61-51H	SPST NO	QC .093"	1.32
E61-02H	SPST NC	QC .093"	1.32	E61-52H	SPST NC	QC .093"	1.32
E61-00K	SPDT	QC .093"	1.50	E61-50K	SPDT	QC .093"	1.50
E61-01K	SPST NO	QC .093"	1.50	E61-51K	SPST NO	QC .093"	1.50
E61-02K	SPST NC	QC .093"	1.50	E61-52K	SPST NC	QC .093"	1.50
E61-10A	SPDT	Solder	1.22	E61-60H	SPDT	Solder	1.32
E61-11A	SPST NO	Solder	1.22	E61-61H	SPST NO	Solder	1.32
E61-12A	SPST NC	Solder	1.22	E61-62H	SPST NC	Solder	1.32
E61-10H	SPDT	Solder	1.32	E61-60K	SPDT	Solder	1.50
E61-11H	SPST NO	Solder	1.32	E61-61K	SPST NO	Solder	1.50
E61-12H	SPST NC	Solder	1.32	E61-62K	SPST NC	Solder	1.50
E61-10K	SPDT	Solder	1.50	E61-80H	SPDT	.110" QC	1.32
E61-11K	SPST NO	Solder	1.50	E61-81H	SPST NO	.110" QC	1.32
E61-12K	SPST NC	Solder	1.50	E61-82H	SPST NC	.110" QC	1.32
E61-30A	SPDT	.110" QC	1.22	E61-80K	SPDT	.110" QC	1.50
E61-31A	SPST NO	.110" QC	1.22	E61-81K	SPST NO	.110" QC	1.50
E61-32A	SPST NC	.110" QC	1.22	E61-82K	SPST NC	.110" QC	1.50
E61-30H	SPDT	.110" QC	1.32				
E61-31H	SPST NO	.110" QC	1.32				
E61-32H	SPST NC	.110" QC	1.32				

Note: To specify 10 amp change part number prefix from E61 to E62 (example: E61-00A Basic 5 amp becomes E62-00A for 10 amp). Prices are same on both E61 and E62 series.

**SUBMINIATURE MODULES/SERIES E61/SERIES E62**

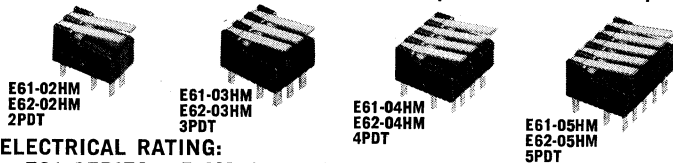

**ELECTRICAL RATING:**  
**E61 SERIES — 5 AMPS., 125/250 VAC**  
**E62 SERIES — 10.1 AMPS., 125/250 VAC 1/4 H.P. 125 VAC**  
 For applications requiring 2, 3, 4, or 5-circuit control in a compact space. The subminiature switch modules have all the features of the regular subminiature switch described above.

Part No.	Circuitry	Terminal	List Price	Part No.	Circuitry	Terminal	List Price
E61-02HM	2PDT	QC .093"	\$2.90	E61-52HM	2PDT	QC .093"	\$2.90
E61-12HM	2PDT	Solder	2.90	E61-62HM	2PDT	Solder	2.90
E61-32HM	2PDT	.110" QC	2.90	E61-82HM	2PDT	.110" QC	2.90
E61-03HM	3PDT	QC .093"	4.50	E61-53HM	3PDT	QC .093"	4.50
E61-13HM	3PDT	Solder	4.50	E61-63HM	3PDT	Solder	4.50
E61-33HM	3PDT	.110" QC	4.50	E61-83HM	3PDT	.110" QC	4.50
E61-04HM	4PDT	QC .093"	6.23	E61-54HM	4PDT	QC .093"	6.23
E61-14HM	4PDT	Solder	6.23	E61-64HM	4PDT	Solder	6.23
E61-34HM	4PDT	.110" QC	6.23	E61-84HM	4PDT	.110" QC	6.23
E61-05HM	5PDT	QC .093"	7.96	E61-55HM	5PDT	QC .093"	7.96
E61-15HM	5PDT	Solder	7.96	E61-65HM	5PDT	Solder	7.96
E61-35HM	5PDT	.110" QC	7.96	E61-85HM	5PDT	.110" QC	7.96

**STANDARD FORCE-MINIATURE SERIES E22/ E23/ E33/ E34**

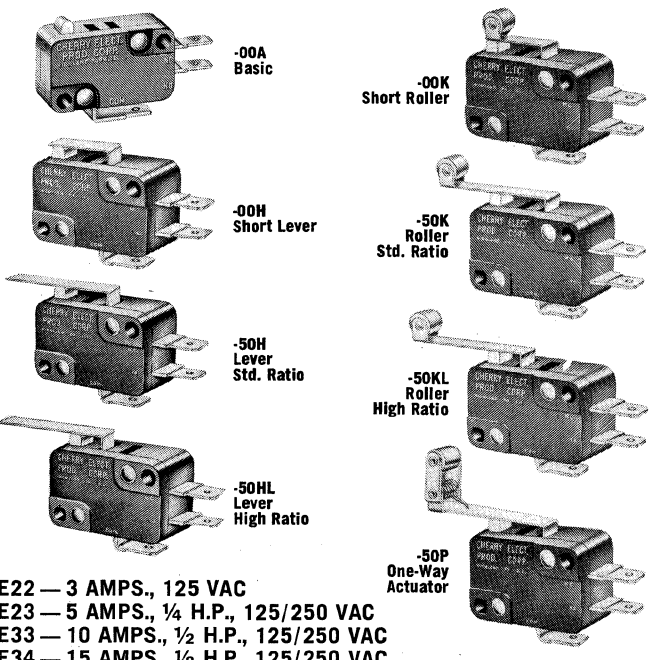

**E22 — 3 AMPS., 125 VAC**  
**E23 — 5 AMPS., 1/4 H.P., 125/250 VAC**  
**E33 — 10 AMPS., 1/2 H.P., 125/250 VAC**  
**E34 — 15 AMPS., 1/2 H.P., 125/250 VAC**  
**SWITCH BODY — 13/32" x 5/8" x 13/32"**  
 Compact miniature switch with long-life coil spring mechanism, integral hinged actuators, choice of three terminal types and four force rating ranges.

(E22 series switches are 20 cents higher than those shown in the table below for E23 series)

Part No.	Circuitry	Terminal	List Price	Part No.	Circuitry	Terminal	List Price
E23-00A	SPDT	QC	\$0.85	E23-00K	SPDT	QC	\$1.20
E23-01A	SPST NO	QC	.82	E23-01K	SPST NO	QC	1.17
E23-02A	SPST NC	QC	.82	E23-02K	SPST NC	QC	1.17
E23-10A	SPDT	Screw	1.36	E23-10K	SPDT	Screw	1.71
E23-11A	SPST NO	Screw	1.19	E23-11K	SPST NO	Screw	1.54
E23-12A	SPST NC	Screw	1.19	E23-12K	SPST NC	Screw	1.54
E23-20A	SPDT	Solder	.85	E23-20K	SPDT	Solder	1.20
E23-21A	SPST NO	Solder	.82	E23-21K	SPST NO	Solder	1.17
E23-22A	SPST NC	Solder	.82	E23-22K	SPST NC	Solder	1.17
E23-00H	SPDT	QC	1.00	E23-50K	SPDT	QC	1.20
E23-01H	SPST NO	QC	.97	E23-51K	SPST NO	QC	1.17
E23-02H	SPST NC	QC	.97	E23-52K	SPST NC	QC	1.17
E23-10H	SPDT	Screw	1.51	E23-60K	SPDT	Screw	1.71
E23-11H	SPST NO	Screw	1.34	E23-61K	SPST NO	Screw	1.54
E23-12H	SPST NC	Screw	1.34	E23-62K	SPST NC	Screw	1.54
E23-20H	SPDT	Solder	1.00	E23-70K	SPDT	Solder	1.20
E23-21H	SPST NO	Solder	.97	E23-71K	SPST NO	Solder	1.17
E23-22H	SPST NC	Solder	.97	E23-72K	SPST NC	Solder	1.17
E23-50H	SPDT	QC	1.00	E23-50KL	SPDT	QC	1.20
E23-51H	SPST NO	QC	.97	E23-51KL	SPST NO	QC	1.17
E23-52H	SPST NC	QC	.97	E23-52KL	SPST NC	QC	1.17
E23-60H	SPDT	Screw	1.51	E23-60KL	SPDT	Screw	1.71
E23-61H	SPST NO	Screw	1.34	E23-61KL	SPST NO	Screw	1.54
E23-62H	SPST NC	Screw	1.34	E23-62KL	SPST NC	Screw	1.54
E23-70H	SPDT	Solder	1.00	E23-70KL	SPDT	Solder	1.20
E23-71H	SPST NO	Solder	.97	E23-71KL	SPST NO	Solder	1.17
E23-72H	SPST NC	Solder	.97	E23-72KL	SPST NC	Solder	1.17
E23-50HL	SPDT	QC	1.00	E23-50P	SPDT	QC	1.55
E23-51HL	SPST NO	QC	.97	E23-51P	SPST NO	QC	1.52
E23-52HL	SPST NC	QC	.97	E23-52P	SPST NC	QC	1.52
E23-60HL	SPDT	Screw	1.51	E23-60P	SPDT	Screw	2.06
E23-61HL	SPST NO	Screw	1.34	E23-61P	SPST NO	Screw	1.89
E23-62HL	SPST NC	Screw	1.34	E23-62P	SPST NC	Screw	1.89
E23-70HL	SPDT	Solder	1.00	E23-70P	SPDT	Solder	1.55
E23-71HL	SPST NO	Solder	.97	E23-71P	SPST NO	Solder	1.52
E23-72HL	SPST NC	Solder	.97	E23-72P	SPST NC	Solder	1.52

Note: To specify E33, 10 amp. series, E34, 15 amp. series or E22, 3 amp. series, merely change the E23 series prefix to the desired series (i.e. E22, E33, E34). Prices on E33 and E34 are the same as the E23 series. The E22 series list prices are 20 cents higher on every switch.

**CHERRY ELECTRICAL PRODUCTS CORPORATION**  
 3600 SUNSET AVENUE / WAUKEGAN, ILLINOIS 60085 / (312) 689-7703 / TWX (910) 235-1572 / CABLE: CHERRY, WAUKEGAN  
 FOR CURRENT SOURCE DATA CALL TOLL-FREE 800-645-9200 (IN N.Y. STATE CALL COLLECT (516) 294-0990)



**LIGHT FORCE - MINIATURE / E22 / E23 / E33 / E34 SERIES**

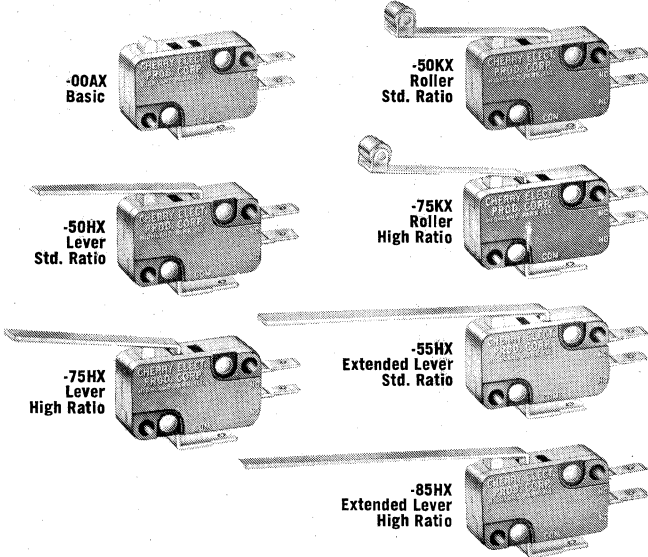

**ELECTRICAL RATINGS**  
 3 AMP., 125 VAC  
 5 AMP., 1/4 H.P., 125/250 VAC  
 10 AMP., 1/2 H.P., 125/250 VAC  
 15 AMP., 1/2 H.P., 125/250 VAC  
**SWITCH BODY** — 1/32" x 5/8" x 1/32"

**SERIES**  
 E22  
 E23  
 E33  
 E34

**OPERATING FORCE**  
 15 GRAMS, MAX.  
 45 GRAMS, MAX.  
 75 GRAMS, MAX.  
 100 GRAMS, MAX.

Part No.	Circuitry	Terminal	List Price	Part No.	Circuitry	Terminal	List Price
E33-00AX	SPDT	QC	\$0.88	E33-75HX	SPDT	QC	\$1.03
E33-01AX	SPST NO	QC	.85	E33-76HX	SPST NO	QC	1.00
E33-02AX	SPST NC	QC	.85	E33-77HX	SPST NC	QC	1.00
E33-10AX	SPDT	Screw	1.39	E33-85HX	SPDT	QC	1.08
E33-11AX	SPST NO	Screw	1.22	E33-86HX	SPST NO	QC	1.05
E33-12AX	SPST NC	Screw	1.22	E33-87HX	SPST NC	QC	1.05
E33-20AX	SPDT	Solder	.88	E33-50KX	SPDT	QC	1.23
E33-21AX	SPST NO	Solder	.85	E33-51KX	SPST NO	QC	1.20
E33-22AX	SPST NC	Solder	.85	E33-52KX	SPST NC	QC	1.20
E33-50HX	SPDT	QC	1.03	E33-60KX	SPDT	Screw	1.74
E33-51HX	SPST NO	QC	1.00	E33-61KX	SPST NO	Screw	1.57
E33-52HX	SPST NC	QC	1.00	E33-62KX	SPST NC	Screw	1.57
E33-60HX	SPDT	Screw	1.54	E33-70KX	SPDT	Solder	1.23
E33-61HX	SPST NO	Screw	1.37	E33-71KX	SPST NO	Solder	1.20
E33-62HX	SPST NC	Screw	1.37	E33-72KX	SPST NC	Solder	1.20
E33-70HX	SPDT	Solder	1.03	E33-75KX	SPDT	QC	1.23
E33-71HX	SPST NO	Solder	1.00	E33-76KX	SPST NO	QC	1.20
E33-72HX	SPST NC	Solder	1.00	E33-77KX	SPST NC	QC	1.20
E33-55HX	SPDT	QC	1.08				
E33-56HX	SPST NO	QC	1.05				
E33-57HX	SPST NC	QC	1.05				

Added internal actuator increases life range, reduces operating force while maintaining high contact pressure.

Note: To specify 3 amp E22 series, 5 amp E23 series, or 15 amp E34 series merely change the E33 series prefix to the desired series (i.e. E22, E23, E34.) The E23 series is 5¢ more, the E34 series is 12¢ more and the E22 is 20¢ more than the E33 series on every switch.

**BASIC OPEN SWITCH - S23/S25 SERIES**

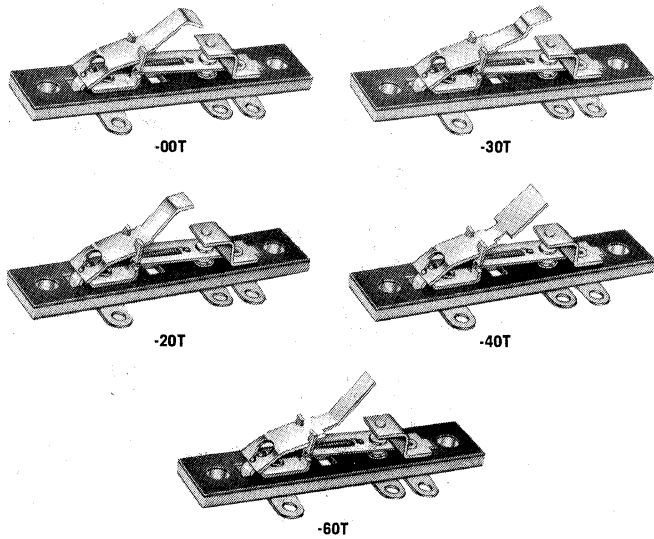

**LIGHT FORCE - S23 SERIES — 5 AMPS., 125 VAC**  
**SWITCH PANEL — 2 1/8" x 7/16" x 3/32"**  
**STANDARD FORCE - S25 SERIES — 10 AMPS., 125 VAC — 5 AMPS., 250 VAC — 1/4 H.P., 125/250 VAC**  
**SWITCH PANEL — 2 1/8" x 7/16" x 3/32"**

Part No.	Circuitry	Description	List Price	Part No.	Circuitry	Description	List Price
S23-00T	SPDT	Flat solder	\$1.02	S23-30W	SPDT	Int. solder	\$1.02
S23-01T	SPST NO	Flat solder	1.02	S23-31W	SPST NO	Int. solder	1.02
S23-02T	SPST NC	Flat solder	1.02	S23-32W	SPST NC	Int. solder	1.02
S23-00Z	SPDT	QC	1.02	S23-40T	SPDT	Flat solder	1.02
S23-01Z	SPST NO	QC	1.02	S23-41T	SPST NO	Flat solder	1.02
S23-02Z	SPST NC	QC	1.02	S23-42T	SPST NC	Flat solder	1.02
S23-00W	SPDT	Int. solder	1.02	S23-40Z	SPDT	QC	1.02
S23-01W	SPST NO	Int. solder	1.02	S23-41Z	SPST NO	QC	1.02
S23-02W	SPST NC	Int. solder	1.02	S23-42Z	SPST NC	QC	1.02
S23-20T	SPDT	Flat solder	1.02	S23-40W	SPDT	Int. solder	1.02
S23-21T	SPST NO	Flat solder	1.02	S23-41W	SPST NO	Int. solder	1.02
S23-22T	SPST NC	Flat solder	1.02	S23-42W	SPST NC	Int. solder	1.02
S23-20Z	SPDT	QC	1.02	S23-60T	SPDT	Flat solder	1.02
S23-21Z	SPST NO	QC	1.02	S23-61T	SPST NO	Flat solder	1.02
S23-22Z	SPST NC	QC	1.02	S23-62T	SPST NC	Flat solder	1.02
S23-20W	SPDT	Int. solder	1.02	S23-60Z	SPDT	QC	1.02
S23-21W	SPST NO	Int. solder	1.02	S23-61Z	SPST NO	QC	1.02
S23-22W	SPST NC	Int. solder	1.02	S23-62Z	SPST NC	QC	1.02
S23-30T	SPDT	Flat solder	1.02	S23-60W	SPDT	Int. solder	1.02
S23-31T	SPST NO	Flat solder	1.02	S23-61W	SPST NO	Int. solder	1.02
S23-32T	SPST NC	Flat solder	1.02	S23-62W	SPST NC	Int. solder	1.02
S23-30Z	SPDT	QC	1.02				
S23-31Z	SPST NO	QC	1.02				
S23-32Z	SPST NC	QC	1.02				

Many variations in actuators, terminals, and panels.

Note: To specify 10 amp. S25 series merely change the S23 prefix to S25. For example, S23-01T SPST NO 5 amp becomes S25-01T SPST NO 10 amp. Prices are the same on S23 and S25 series.

**MINIATURE OPEN - S30 SERIES**

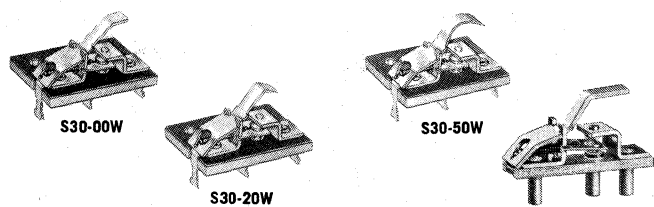

**ELECTRICAL RATINGS**  
 10 AMPS., 125 VAC — 5 AMPS., 250 VAC — 1/4 HP 125/250 VAC  
**SWITCH PANEL — 1 1/16" x 3/4" x 3/32"**  
 Many variations in actuators, terminals, and panels.

Part No.	Circuitry	Description	List Price	Part No.	Circuitry	Description	List Price
S30-00W	SPDT	Int. solder	\$1.02	S30-50W	SPDT	Int. solder	\$1.02
S30-01W	SPST NO	Int. solder	1.02	S30-51W	SPST NO	Int. solder	1.02
S30-02W	SPST NC	Int. solder	1.02	S30-52W	SPST NC	Int. solder	1.02
S30-00T	SPDT	Flat solder	1.02	S30-50T	SPDT	Flat solder	1.02
S30-01T	SPST NO	Flat solder	1.02	S30-51T	SPST NO	Flat solder	1.02
S30-02T	SPST NC	Flat solder	1.02	S30-52T	SPST NC	Flat solder	1.02
S30-00Z	SPDT	QC	1.02	S30-50Z	SPDT	QC	1.02
S30-01Z	SPST NO	QC	1.02	S30-51Z	SPST NO	QC	1.02
S30-02Z	SPST NC	QC	1.02	S30-52Z	SPST NC	QC	1.02
S30-20W	SPDT	Int. solder	1.02	S30-20P	SPDT	PC Term.	1.14
S30-21W	SPST NO	Int. solder	1.02	S30-21P	SPST NO	PC Term.	1.14
S30-22W	SPST NC	Int. solder	1.02	S30-22P	SPST NC	PC Term.	1.14
S30-20T	SPDT	Flat solder	1.02	S30-20Z	SPDT	Flat solder	1.02
S30-21T	SPST NO	Flat solder	1.02	S30-21Z	SPST NO	Flat solder	1.02
S30-22T	SPST NC	Flat solder	1.02	S30-22Z	SPST NC	Flat solder	1.02
S30-20Z	SPDT	QC	1.02	S30-50Z	SPDT	QC	1.02
S30-21Z	SPST NO	QC	1.02	S30-51Z	SPST NO	QC	1.02
S30-22Z	SPST NC	QC	1.02	S30-52Z	SPST NC	QC	1.02

CHERRY ELECTRICAL PRODUCTS CORPORATION  
 3600 SUNSET AVENUE / WAUKEGAN, ILLINOIS 60085 / (312) 689-7703 / TWX (910) 235-1572 / CABLE: CHERRY, WAUKEGAN  
 FOR CURRENT SOURCE DATA CALL TOLL-FREE 800-645-9200 (IN N. Y. STATE CALL COLLECT (516) 294-0990)



## ENCLOSED - SINGLE THROW/E10/E15/E16/E18 SERIES

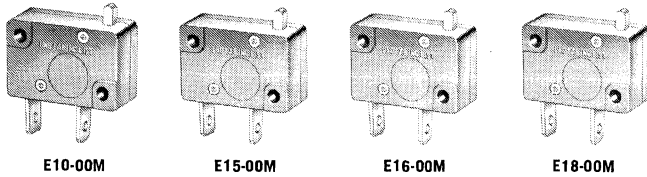

E10-00M—NC, 10 AMPS., 1/3 H.P., 125 VAC — 5 AMPS., 250 VAC  
 E15-00M—NC, 6 AMPS., 125 VAC — 3 AMPS., 250 VAC  
 E16-00M—NO, 2 AMPS., 125 VAC — 1 AMP., 250 VAC  
 E18-00M—NO, 3 1/4 AMPS., 125 VAC

A single pole, single throw switch with light force and large overtravel. Solderable QC 1/4" terminals. Switch body: 1 1/8" x 3/4" x 1/8".

Part No.	Circuitry	List Price	Part No.	Circuitry	List Price
E10-00M	SPST NC	\$0.91	E16-00M	SPST NO	\$0.91
E15-00M	SPST NC	.91	E18-00M	SPST NO	.91

## STACK SWITCHES/S36/S37 SERIES

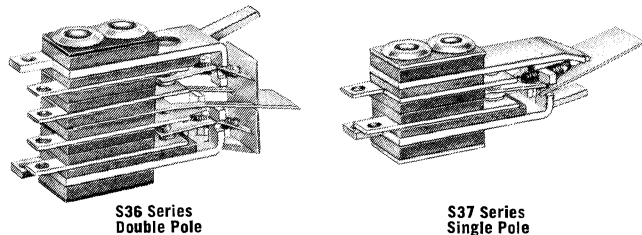

ELECTRICAL RATING:  
 7 1/2 AMPS., 125 VAC  
 5 AMPS., 250 VAC

Available in single or double pole with momentary or reset (maintained) contact action.

SWITCH BODY: 1 1/4" x 3 7/64" x 5/16"

Part No.	Circuitry	List Price	Part No.	Circuitry	List Price
S36-20E	DPDT (R)	\$2.40	S37-10E	SPDT (R)	\$1.53
S36-21E	DPST NO (R)	2.35	S37-11E	SPST NO (R)	1.50
S36-22E	DPST NC (R)	2.35	S37-12E	SPST NC (R)	1.50
S36-40E	DPDT (M)	2.40	S37-20E	SPDT (M)	1.53
S36-41E	DPST NO (M)	2.35	S37-21E	SPST NO (M)	1.50
S36-42E	DPST NC (M)	2.35	S37-22E	SPST NC (M)	1.50

Note: (R) Denotes reset (maintained) contact action.  
 (M) Denotes momentary contact action.

## CHERRY GOLD "CROSSPOINT" CONTACT SWITCHES

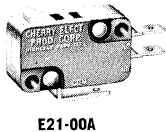

E21-00A

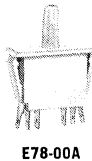

E78-00A

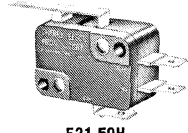

E21-50H



G13-00E

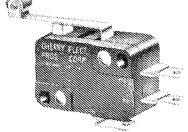

E21-50K

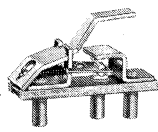

S31-20P

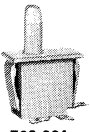

E68-00A

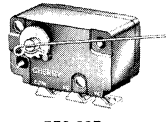

E53-00B

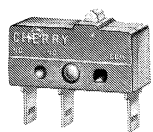

E63-00A

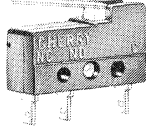

E63-00H

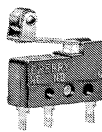

E63-00K

Cherry Gold "Crosspoint" Contact switches are available in a wide variety of switch types and mountings as shown above. These provide extremely low insertion resistance and long life... measured in millions of operations. The contact material is W/E Alloy #1... 69% Gold, 25% Silver, 6% Platinum.

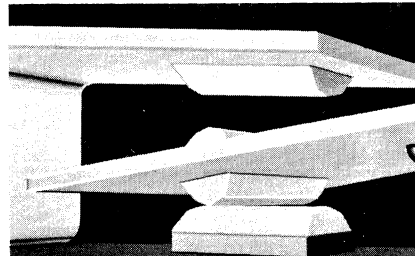

For positive switching of low energy solid state circuits.

The Cherry "Crosspoint" contact configuration... (two gold contact prisms at right angles to each other) provide maximum contact pressure and minimum hazard of contact closure interference.

Part No.	Circuitry	Terminal	List Price	Part No.	Circuitry	Terminal	List Price
E21-00A	SPDT	QC	\$1.57	S31-20P	SPDT	PC	\$1.50
E21-01A	SPST NO	QC	1.25	S31-21P	SPST NO	PC	1.18
E21-02A	SPST NC	QC	1.25	S31-22P	SPST NC	PC	1.18
E21-10A	SPDT	Screw	2.08	E53-00B	SPDT		2.76
E21-11A	SPST NO	Screw	1.59	E53-01B	SPST NO		2.76
E21-12A	SPST NC	Screw	1.59	E53-02B	SPST NC		2.76
E21-20A	SPDT	Solder	1.57	E63-00A	SPDT	QC .093"	1.86
E21-21A	SPST NO	Solder	1.25	E63-01A	SPST NO	QC .093"	1.86
E21-22A	SPST NC	Solder	1.25	E63-02A	SPST NC	QC .093"	1.86
E21-50H	SPDT	QC	1.72	E63-10A	SPDT	Solder	1.86
E21-51H	SPST NO	QC	1.40	E63-11A	SPST NO	Solder	1.86
E21-52H	SPST NC	QC	1.40	E63-12A	SPST NC	Solder	1.86
E21-60H	SPDT	Screw	2.23	E63-30A	SPDT	QC .110"	1.86
E21-61H	SPST NO	Screw	1.74	E63-31A	SPST NO	QC .110"	1.86
E21-62H	SPST NC	Screw	1.74	E63-32A	SPST NC	QC .110"	1.86
E21-70H	SPDT	Solder	1.72	E63-00H	SPDT	QC .093"	1.96
E21-71H	SPST NO	Solder	1.40	E63-01H	SPST NO	QC .093"	1.96
E21-72H	SPST NC	Solder	1.40	E63-02H	SPST NC	QC .093"	1.96
E21-50K	SPDT	QC	1.92	E63-10H	SPDT	Solder	1.96
E21-51K	SPST NO	QC	1.60	E63-11H	SPST NO	Solder	1.96
E21-52K	SPST NC	QC	1.60	E63-12H	SPST NC	Solder	1.96
E21-60K	SPDT	Screw	2.43	E63-30H	SPDT	QC .110"	1.96
E21-61K	SPST NO	Screw	1.94	E63-31H	SPST NO	QC .110"	1.96
E21-62K	SPST NC	Screw	1.94	E63-32H	SPST NC	QC .110"	1.96
E21-70K	SPDT	Solder	1.92	E63-00K	SPDT	QC .093"	2.14
E21-71K	SPST NO	Solder	1.60	E63-01K	SPST NO	QC .093"	2.14
E21-72K	SPST NC	Solder	1.60	E63-02K	SPST NC	QC .093"	2.14
E68-00A	SPDT	QC	1.59	E63-10K	SPDT	Solder	2.14
E68-01A	SPST NO	QC	1.59	E63-11K	SPST NO	Solder	2.14
E68-02A	SPST NC	QC	1.59	E63-12K	SPST NC	Solder	2.14
E78-00A	DPDT	QC	2.83	E63-30K	SPDT	QC .110"	2.14
E78-01A	DPST NO	QC	2.83	E63-31K	SPST NO	QC .110"	2.14
E78-02A	DPST NC	QC	2.83	E63-32K	SPST NC	QC .110"	2.14
G13-00E	SPDT	QC	1.39				
G13-01E	SPST NO	QC	1.07				
G13-02E	SPST NC	QC	1.07				

### CHERRY ELECTRICAL PRODUCTS CORPORATION

3600 SUNSET AVENUE / WAUKEGAN, ILLINOIS 60085 / (312) 689-7703 / TWX (910) 235-1572 / CABLE: CHERRY, WAUKEGAN  
 FOR CURRENT SOURCE DATA CALL TOLL-FREE 800-645-9200 (IN N.Y. STATE CALL COLLECT (516) 294-0990)

# CHERRY

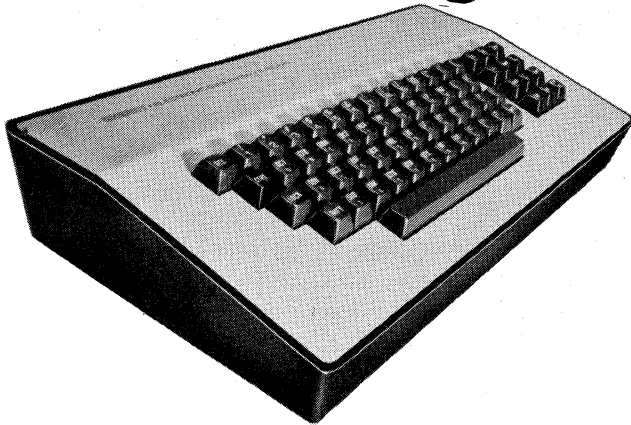

**B80-3766**  
Keyboard enclosure available  
at nominal extra cost.

## ELECTRONIC DATA ENTRY KEYBOARDS

Straightforward electronics adapt readily to customer specifications. Custom design in mono, dual, tri and quad mode operation are available in volume application with modest engineering, tooling, and art work charges.

Standard units include:

B80-3766, 66 Key Tri Mode ASCII negative logic with provision to add 4 extra keys.

B70-4753, 53 Key Quad Mode ASCII (ASR 33) positive logic.

B65-1712, 12 Key Numeric straight output.

## KEYBOARD SWITCHES

for modern electronic desk top calculators . . . computer terminals . . . credit card validators. NEW Gold "Crosspoint" contact key.

This proven design concept (crossed knife edge contact configuration) provides high force per unit of contact area, and virtually eliminates contact closure interference by contaminants. Contacts are normally held apart for greater shock resistance. No microphonics or bounce during turn-off or at rest.

Three types with straight or angled stems for sloped or stepped keyboards.

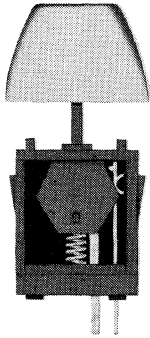

### THREE TYPES TO CHOOSE FROM WITH STRAIGHT OR ANGLED STEMS FOR SLOPED OR STEPPED KEYBOARDS

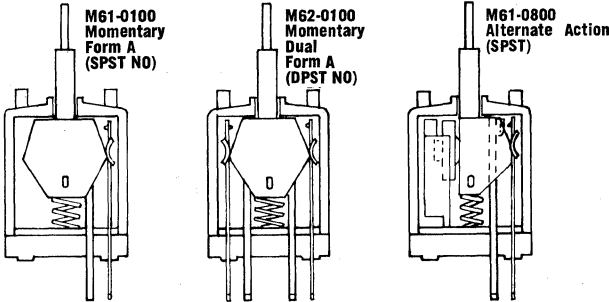

Write for this handy,  
six-page **KEYBOARD  
DESIGNERS'  
SPECIFICATION  
SHEET**



### KEYBOARD PRICE LIST

Net Price For Quantity	B80-3766 66-Key ASCII Tri-Mode	B70-4753 53-Key ASCII Quad-Mode	B65-1712 12-Key Numeric Non-Encoded
1 - 9	\$228.00 each	\$214.00 each	\$32.50 each
10 - 24	209.00 each	196.00 each	29.75 each
25 - 49	190.00 each	178.00 each	27.10 each
50 - 99	158.00 each	148.00 each	22.60 each
100 - 249	127.00 each	119.00 each	18.05 each
250 - 499	95.50 each	89.10 each	13.60 each
500 - 999	82.50 each	77.25 each	11.75 each

For prices on quantities greater than shown in price list, consult factory.

### KEYBOARD SWITCH PRICE LIST

Net Price For Quantity	M61-0100 Single Form A (SPST NO)	M62-0100 Dual Form A (DPST NO)	M61-0800 Alternate Action (SPST)
1 - 49	\$1.27 each	\$1.97 each	\$1.88 each
50 - 99	0.90 each	1.44 each	1.37 each
100 - 499	0.78 each	1.24 each	1.18 each
500 - 999	0.70 each	1.12 each	1.07 each
1000 - 1999	0.65 each	1.03 each	0.98 each
2000 - 4999	0.57 each	0.91 each	0.87 each
5000 - 9999	0.50 each	0.81 each	0.77 each

### 8 REASONS YOU SPECIFY CHERRY WITH CONFIDENCE:

1. Cherry keyboard and key switch components as well as assembled keyboards are made under one roof.
2. We make our own printed circuit board.
3. We make our own two-shot molded key caps.
4. We have a large assortment of tooled key cap legends in two type faces and a variety of sizes.
5. We offer a wide choice of standard key cap colors.
6. We install and wave solder the electronics to the pc board.
7. We provide a choice of MOS or TTL.
8. Cherry Keyboards are backed by 20 years experience in the design and manufacture of precision snap-action switches, matrix selector switches, gold "crosspoint" contact switches and leverwheel/thumbwheel switches.





## THUMBWHEEL AND LEVERWHEEL SWITCHES

### DISCOUNT SCHEDULE

Quantity	Discount	Multiplier
1-49	List	1.00
50-99	20%	.80
100-199	25%	.73
200-499	27%	.73
500-999	30%	.70
1000-1999	32%	.68
2000-4999	34%	.66

For prices on quantities of 5000 pieces and over, consult factory or contact nearest representative.

### LIST PRICE ADDERS FOR OPTIONS AND SPECIAL FEATURES

Two Sided Printed Circuit Board	\$1.25
Special Code	1.00
Extended PC Board (one side)	1.00
Spacers 1/4" or 1/2" (blank, gloss or matte)	0.50
Adding Symbol to Spacer	0.50
Adding Stops (per switch)	0.75
Matte Finish (per switch)	0.30
End Caps (per set)	0.80
Assembly of Modules labor only, no parts) for first switch —	\$0.50
\$0.30 each additional switch or spacer in the Module (\$3.00 maximum)	
Assembly Hardware (per set-unassembled)	0.50

Thumbwheel and Leverwheel switches are available in nine basic configurations — in a broad range of coded outputs — in individual digits — in assemblies of several digits mounted side-by-side complete with end caps — in gloss or matte finish. T71 Series Decimal Point switch for calculators not listed in table below is available in all the same output codes shown for T60 and T70 except Hexadecimal. For complete information and prices on T71, consult factory.

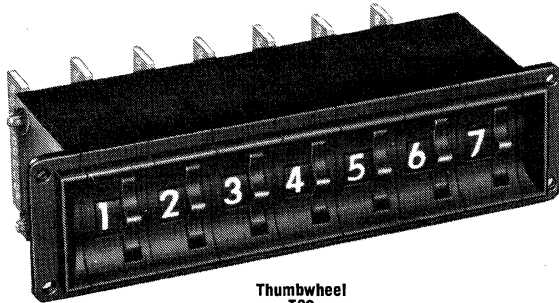

Thumbwheel  
T20  
Back Mount  
Subminiature  
7 Gang Assembly

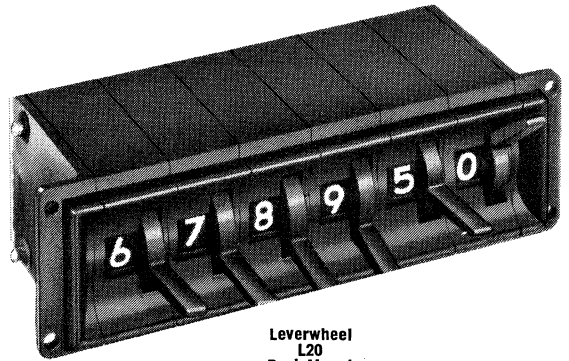

Leverwheel  
L20  
Back Mount  
Subminiature  
6 Gang Assembly

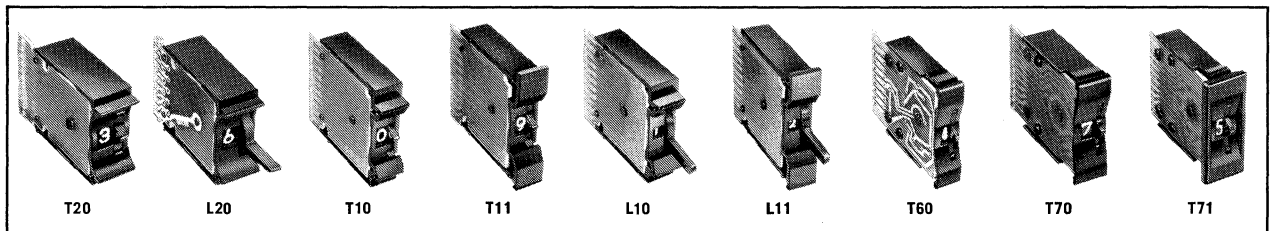

Note: All list prices shown in the following table are subject to discount schedule shown above.

Suffix No.	Position	Description	Readout	T20	L20	T10	T11	L10	L11	T60	T70
-94A	2	Single pole, repeating	(-, +)	\$4.00	\$5.00	\$4.50	\$4.50	\$5.00	\$5.00	\$3.50	\$3.50
-95A	2	Single pole, repeating	(0-1)	4.00	5.00	4.50	4.50	5.00	5.00	3.50	3.50
-96A	2	Single pole, repeating	(0-5)	4.00	5.00	4.50	4.50	5.00	5.00	3.50	3.50
-97A	2	Double Pole, Repeating	(+, 1)							4.50	4.50
-07A	8	Binary Coded Octal	(0-7)	4.00	5.00	5.00	5.00	5.50	5.50	3.50	3.50
-47A	8	BCO with separate common To not true bits	(0-7)	7.50	8.50						
-17A	8	Decimal	(0-7)	4.00	5.00						
-57A	8	BCO with diode provision	(0-7)	5.00	6.00						
-77A	8	BCO complement only	(0-7)	4.50	5.50					4.00	4.00
-01A	10	Decimal	(0-9)	4.00	5.00	4.50	4.50	5.10	5.10	3.00	3.00
-11A	10	Double pole decimal	(0-9)	8.60	9.20	8.60	8.60	9.20	9.20		
-69A	10	Decimal	(0-9)	4.00	5.00						
-02A	10	Binary Coded Decimal	(0-9)	4.00	5.00	4.50	4.50	5.10	5.10	3.00	3.00
-04A	10	BCD plus complement, 1 common	(0-9)	5.00	6.00	6.80	6.80	7.80	7.80	4.00	4.00
-05A	10	BCD plus complement, 2 commons	(0-9)					9.50	9.50		
-06A	10	BCD plus odd parity	(0-9)	5.15	6.10					5.00	5.00

### CHERRY ELECTRICAL PRODUCTS CORPORATION

3600 SUNSET AVENUE / WAUKEGAN, ILLINOIS 60085 / (312) 689-7703 / TWX (910) 235-1572 / CABLE: CHERRY, WAUKEGAN  
FOR CURRENT SOURCE DATA CALL TOLL-FREE 800-645-9200 (IN N.Y. STATE CALL COLLECT (516) 294-0990)



**THUMBWHEEL AND LEVERWHEEL SWITCHES (Cont'd.)**

Suffix No.	Position	Description	Readout	T20	L20	T10	T11	L10	L11	T60	T70
-10A	10	BCD plus even parity	(0-9)	\$5.15	\$6.10			\$7.10	\$7.10	\$5.00	\$5.00
-12A	10	BCD complement only	(0-9)	4.50	5.50					4.00	4.00
-15A	10	BCD with separate common To not true bits	(0-9)	7.50	8.50						
-14A	10	9's complement of BCD	(0-9)	5.00	6.00						
-52A	10	BCD with diode provisions	(0-0)	5.00	6.00	\$5.50	\$5.50			4.00	4.00
-54A	10	BCD plus complement, 1 common with diode provision	(0-9)	6.00	7.00	7.80	7.80				
-68A	10	Two out of five code with diode provision	(0-9)	6.00	7.00						
-72A	10	Complement of 9's complement with diode provision	(0-9)	6.00	7.00						
-65A	10	Kelvin-Varley voltage divider	(0-9)	8.50	9.50						
-67A	10	1-2-2-2-2 resistive decade	(0-9)	8.00	9.00						
-20A	12	Decimal	(0-11)		5.00						
-03A	16	Hexadecimal	(0-15)	6.50		7.50	7.50			5.50	5.50
-08A	16	Hexadecimal plus complement, 1 common	(0-15)	7.50		8.50	8.50				
-09A	16	Hexadecimal plus complement, 2 commons	(0-15)	8.50		9.50	9.50				
-13A	16	Hexadecimal	(0-9,A-F)	6.50		7.50	7.50			5.50	5.50
-53A	16	Hexadecimal with diode provision	(0-15)	7.50							
-19A	16	Hexadecimal plus complement, 2 commons	(0-9,A-F)			9.50	9.50				
-63	16	Hexadecimal with diode provision	(0-9,A-F)	7.50							
-88A	16	Hexadecimal plus complement, 1 common	(0-9,A-F)	7.50							
-89A	16	Hexadecimal plus complement, 2 commons	(0-9,A-F)	8.50							
-50A	10	Excess 3 gray code positive	(0-9)							5.00	5.00
-49A	10	Excess 3 gray code negative	(0-9)							5.00	5.00
-70A	10	Aiken code 1-2-4-2	(0-9)							5.00	5.00
-71A	10	Aiken code modern 1-2-4-2	(0-9)							5.00	5.00

(Note: T71 Integral Bezel Decimal Point Set Thumbwheel is available in output codes same as all T60 and T70 except it is not available in Hexadecimal.)

**MATRIX SELECTOR SWITCH**

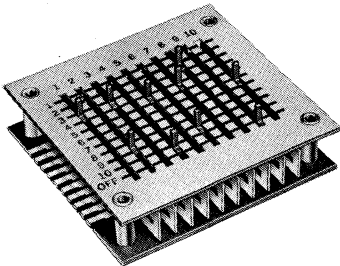

Manual programming and switching for complex control equipment. Each of two standard types is expandable up to five modules, providing 500 to 1,000 crosspoints. Custom design available up to 2,784 crosspoints.

**Electrical capacity:**

1. Make and break 48 volts DC at 0.50 Amp. 125 Volts AC at 0.15 Amp.
2. Current carrying only (no make and break) 2 Amp. AC or DC.

**Insertion Resistances:**

50 milliohms plus 6 milliohms per inch of printed circuit.

Note: Overall width of basic 10 x 10 and 20 x 10 Selector Switch is 3 1/2 inches. For each 10 sliders added to the basic unit add 3 inches to overall width. A 20 slider unit measures 6 1/2 inches wide; a 30 slider unit measures 9 1/2 inches wide; a 40 slider unit measures 12 1/2 inches wide and a 50 slider unit measures 15 1/2 inches wide.

**DISCOUNT SCHEDULE**

Quantity	Discount	Multiplier
1-9	List	1.00
10-24	10%	0.90
25-49	15%	0.85
50-99	20%	0.80
100-249	25%	0.75
250-499	30%	0.70

For quantities of 500 and over consult factory or contact nearest representative.

Switch No.	Circuitry	List Price	Switch No.	Circuitry	List Price
C10-01A	20 x 10	\$35.00	C10-20A	10 x 10	\$25.00
C10-02A	20 x 20	40.00	C10-42A	10 x 20	32.50
C10-03A	20 x 30	60.00	C10-43A	10 x 30	43.00
C10-04A	20 x 40	65.00	C10-44A	10 x 40	55.00
C10-05A	20 x 50	75.00	C10-45A	10 x 50	67.00
			C10-56A	48 x 58	204.00

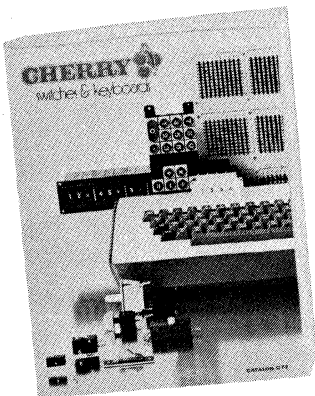

for complete specifications  
on all cherry products request  
**CATALOG C-73**  
for the cherry sales office  
and representative nearest you  
**DIAL (800) 645-9200 TOLL FREE**



3600 SUNSET AVENUE / WAUKEGAN, ILLINOIS 60085 / (312) 689-7703 / TWX (910) 235-1572 / CABLE: CHERRY, WAUKEGAN



Cherry affiliates worldwide • Hirose Cherry Precision Co., Ltd., Tokyo • G. W. Engineering Pty. Ltd., Sydney  
Cherry Electrical Products (U.K.) Ltd., St. Albans, Herts • Cherry Mikroschalter GmbH, Bayreuth, Germany

FOR CURRENT SOURCE DATA CALL TOLL-FREE 800-645-9200 (IN N.Y. STATE CALL COLLECT (516) 294-0990)