

# *the Bakery Chef™ Hub*

Instruction Book - LEM750



**Breville®**



## Contents

- 2 Breville Recommends Safety First
- 9 Components
- 11 Assembly
- 14 Functions
- 18 Care, Cleaning & Storage
- 19 Tips
- 23 Troubleshooting
- 24 Recipes

## BREVILLE RECOMMENDS SAFETY FIRST

**At Breville we are very safety conscious. We design and manufacture consumer products with the safety of you, our valued customer, foremost in mind. In addition, we ask that you exercise a degree of care and adhere to the following precautions.**

## IMPORTANT SAFEGUARDS

### **READ ALL INSTRUCTIONS BEFORE USE AND SAVE FOR FUTURE REFERENCE**

- Carefully read all instructions before operating the Breville bench mixer for the first time and save for future reference.
- Remove and safely discard any packaging material and promotional labels before using the bench mixer for the first time.
- To eliminate a choking hazard for young children, remove and safely discard the protective cover fitted to the power plug of this bench mixer.

- Do not place the bench mixer near the edge of a bench or table during operation. Ensure the surface is level, clean and free of water and other substances. Vibration during operation may cause the bench mixer to move.
- Do not use the bench mixer on a sink drain board.
- Do not place the bench mixer on or near a hot gas or electric burner or where it could touch a heated oven.
- Always ensure the bench mixer is properly assembled before operating. Follow the instructions provided in this book.
- Do not operate the bench mixer with wet hands.
- Ensure the speed control dial is in the OFF position, the bench mixer is switched off at the power outlet and the power cord is unplugged before attaching the mixing bowl or any mixing accessories (scraper beater, whisk and dough hook) or any hub attachments (sold separately).
- Do not use accessories other than those provided with the bench mixer. Use only the accessories, and mixing bowl supplied with the bench mixer.
- Do not operate the dough hook, scraper beater or whisk on the bench mixer when attaching hub attachments ( sold separately ) on the bench mixer to avoid injury or damage to the appliance.
- Do not use hub attachments (sold separately) other than those specifically designed for this bench mixer.

- Do not operate this bench mixer continuously on heavy loads for more than 3 minutes at a time. None of the recipes in this book are considered a heavy load.
- The bench mixer can be used for mixing yeast dough. When doing this, fill the mixing bowl with a mass of flour not exceeding 35% of the bowls' maximum capacity.
- Handle the bench mixer, accessories and attachments with care. Never place your fingers inside the mixing bowl or near the accessories or hub attachments during operation.
- Keep hands, hair, clothing as well as spatulas and other utensils away from the accessories and mixing bowl during operation to reduce the risk of injury to persons and / or damage to the bench mixer.
- Should an object, such as a spoon or spatula fall into the bowl while mixing, immediately switch the bench mixer to the OFF position on the speed control dial, turn off at the power outlet and remove the cord from the power outlet, then remove the object.
- Be careful when handling the bench mixer that the attachment hub cover on the front of the motor head does not become dislodged and fall into the bowl during operation.
- Do not place hands in the mixing bowl unless the bench mixer is disconnected from the power outlet.
- Ensure the motor and the mixing accessory (or hub attachment) has completely stopped before disassembling.

- Always remove the accessory (or hub attachment) from the bench mixer before cleaning. Care should be taken when removing the food from the mixing bowl by ensuring the motor and the accessory have completely stopped before disassembling.
- Ensure the speed control dial is in the OFF position, the bench mixer is switched off at the power outlet and unplugged before tilting the bench mixer motor head into the diagonal (open) position. The mixing accessory should be released from the mixer head before attempting to remove food from the mixer bowl and the accessory.
- Ensure the bench mixer head is locked into the horizontal (closed) position when not in use and before storing.
- Always ensure the speed control dial is in the OFF position, the power is switched off at the power outlet before attempting to move the bench mixer, before assembling or disassembling the bench mixer, when the bench mixer is not in use and before cleaning or storing.
- Always switch OFF the bench mixer and disconnect from the power outlet before removing any hub attachment, changing accessories or approaching parts that move in use.
- Do not move the bench mixer whilst in operation.
- Do not cover the air vents on the mixer head and mixer stand to avoid overheating.
- The use of any mixing accessory or hub attachment not recommended by Breville may cause injuries.

- Do not leave the bench mixer unattended when in use.
- Do not place any part of the bench mixer except the mixing bowl in the dishwasher.
- Do not place the bench mixer in direct sunlight. Colour fading and discolouration may occur when the bench mixer is consistently exposed to UV light.
- Keep the bench mixer clean. Follow the Care, Cleaning and Storage instructions provided in this book.



### CAUTION

In order to avoid a hazard due to inadvertent resetting of the thermal cut-out, this bench mixer must not be supplied through an external switching device, such as a timer, or connected to a circuit that is regularly switched on and off by the utility.

## IMPORTANT SAFEGUARDS FOR ALL ELECTRICAL APPLIANCES

- Fully unwind the power cord before use.
- Connect only to a 230V or 240V power outlet.
- The appliance must be used on a properly grounded outlet. If it is not sure, please consult a qualified electrician.
- Do not, under any circumstances, modify the power plug or use a power plug adapter.
- Do not place this appliance on or near a heat source, such as hot plate, oven or heaters.
- Position the appliance at a minimum distance of 20cm away from walls, curtains and other heat or steam sensitive materials and provide adequate space above and on all sides for air circulation.

- Do not let the power cord hang over the edge of a bench or table, touch hot surfaces or become knotted.
- This appliance is for household use only. Do not use this appliance for anything other than its intended use. Do not use in moving vehicles or boats. Do not use outdoors. **Misuse may cause injury.**
- The appliance is not intended for use by persons (including children) with reduced physical, sensory or mental capabilities, or lack of experience and knowledge, unless they have been given supervision or instruction concerning use of the appliance by a person responsible for their safety.
- Children should be supervised to ensure that they do not play with the appliance.
- Always turn the appliance to the OFF position, switch off at the power outlet and unplug at the power outlet when the appliance is not in use.
- Before cleaning, always turn the appliance to the OFF position, switch off at the power outlet, unplug at the power outlet and remove the power cord, if detachable, from the appliance and allow all parts to cool.
- To protect against electric shock, do not immerse the power cord, power plug or appliance in water or any other liquid or allow moisture to come in contact with the parts, unless it is recommended in the cleaning instructions.

- Any maintenance other than cleaning should be performed at an authorised Breville Service Centre.
- It is recommended to regularly inspect the appliance. To avoid a hazard, do not use the appliance if power cord, power plug or appliance becomes damaged in any way. Return the entire appliance to the nearest authorised Breville Service Centre for examination and/or repair.
- The installation of a residual current device (safety switch) is recommended to provide additional safety protection when using electrical appliances. It is advisable that a safety switch with a rated residual operating current not exceeding 30mA be installed in the electrical circuit supplying the appliance. See a qualified electrician for professional advice.
- During electrical storms, the appliance should be disconnected from the power source at the wall socket to prevent any electrical surges that may arise during the storm and which may inadvertently cause damage to the appliance and its electronic componentry.

**FOR HOUSEHOLD USE ONLY  
SAVE THESE INSTRUCTIONS**





# Components

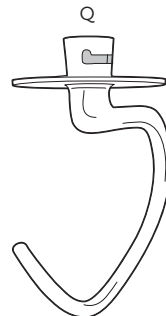
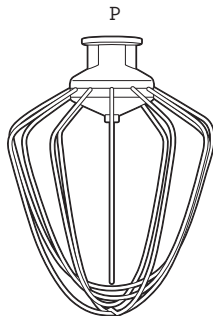
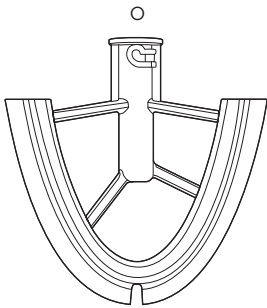



## Components

- A. Mixer motor head**  
Powerful motor for all your mixing needs.
- B. Bowl illumination light**  
Helps to illuminate contents of the bowl while mixing.
- C. Mixer stand with cord storage**  
Push the cord in up to the Breville assist power plug to store.
- D. 7 speed illuminated control dial with push to pause**  
Adjust speed and handy press to pause feature to pause mixing.
- E. Tilt release button**  
Spring release for the mixer motor head to tilt and lock in an upward (diagonal) or downward (horizontal) position.
- F. Timer display**  
Counts up when mixing starts, or use the arrow buttons to set timer to count down.
- G. Motor overload protection system**  
Prevents the motor from overheating.
- H. Hub attachments drive with magnetic cover**  
Removable, magnetic hub cover for access to the hub drive when using attachments (sold separately).
- I. Hub attachment release button**  
Releases the lock on the hub attachment once attached to the mixer.
- J. Motor spindle**  
For attaching the accessories, scraper beater, whisk and dough hook, to complete various mixing tasks.
- K. Two piece splash guard with pouring spout**  
Minimises splattering and allows ingredients to be added while mixing without removal.

- L. Stainless steel mixing bowl**  
4.8L bowl with handle for lifting and scraping the bowl with greater ease.
- M. Bowl locking recess**  
Locks the mixing bowl in place during all mixing tasks.
- N. Non-slip feet**  
Increased stability when mixing.

### INCLUDED MIXING ACCESSORIES

- O. Scraper Beater**  
For a variety of mixing tasks.
- P. Whisk**  
For incorporating air into mixtures.
- Q. Dough Hook**  
For mixing and kneading yeast-based dough.



### NOTE

Always begin mixing at a low speed to prevent splattering. Once the ingredients are combined, increase to the required speed.



## Assembly

### BEFORE FIRST USE

Before using your mixer for the first time, remove any packaging material and promotional labels. Ensure all parts and accessories are accounted for before disposing of the packaging.

When assembling or removing any parts on the mixer, always ensure the speed control dial is in the OFF (0) position, the mixer is switched off at the power outlet and the power cord is unplugged.

Wash the mixing bowl and all mixing accessories in warm soapy water with a soft cloth. Rinse and dry thoroughly.

The mixing bowl can be washed in the dishwasher.

When first using your mixer, you may notice an odour coming from the motor. This is normal and will dissipate with use.

### TILTING AND LOWERING THE MOTOR HEAD

1. The mixer motor head has spring assisted elevation. The mixer motor head should always be locked in the horizontal position when lifting and moving. The mixer motor head should be tilted upwards when attaching or removing the mixing bowl or any mixing accessories, excluding hub attachments.
2. Place the mixer on a dry level surface. To tilt the mixer motor head, with one hand holding the front of the motor head to help control the ascent (near the attachment hub), use the other hand to press firmly on the tilt release button. Tilt the motor head back and upwards until it is fully elevated and is locked into place. (Fig. 1)

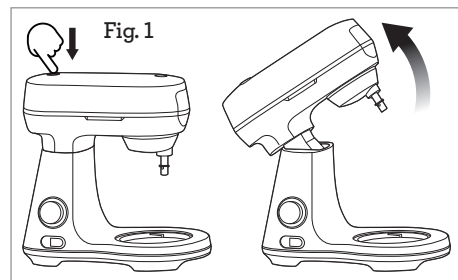

### IMPORTANT

Always use one hand to control the tilting and lowering of the motor head.

It is important that the mixing accessory is securely and correctly locked into position on the mixer spindle to ensure that the mixer operates correctly.

3. Attach the bowl and mixer accessory required before returning the motor head to the horizontal position.

4. To lower the mixer motor head, hold the front of the mixer head with one hand to assist with lowering, and press the tilt release button with the other. Lower the mixer motor head back to the horizontal position until it locks in place.

## ATTACHING AND REMOVING THE MIXING BOWL

1. Ensure the motor head is tilted upwards into a diagonal position and locked into place before attaching or removing the mixer bowl. The mixing bowl should be in place before attaching any mixing accessories.
2. With the motor head tilted upwards and holding the mixing bowl by the handle, insert the base of the bowl into the bowl locking recess by aligning the notches on the bowl and the grooves on the mixer base. Turn the bowl in a clockwise direction, following the **TIGHTEN** line found on the base of the mixer, to securely lock the bowl in place.

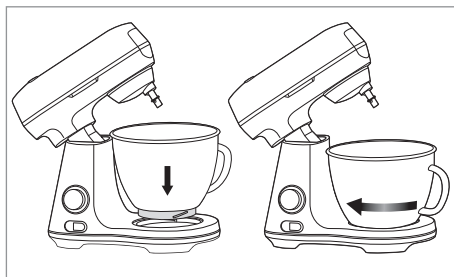

3. To remove the bowl, with the motor head tilted upwards and holding the mixing bowl by the handle, turn the bowl in an anti-clockwise direction, turning against the **TIGHTEN** line until the bowl notches align with the grooves on the mixer base. Lift the bowl from the mixer.

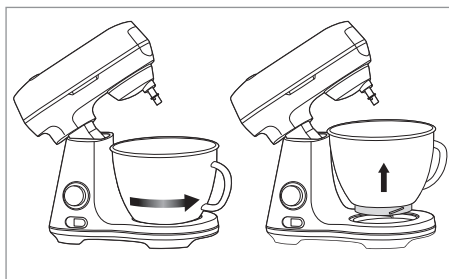

## ATTACHING AND REMOVING THE MIXING ACCESSORIES

1. Ensure the motor head is tilted into a diagonal position and locked into place and the bowl is secured in place before attaching or removing any mixing accessories.
2. Align the groove in the top of the selected accessory with the notch found on the mixer spindle.
3. Push the accessory upwards onto the spindle and rotate the accessory anti-clockwise to secure. Pull the accessory downwards to lock into position.

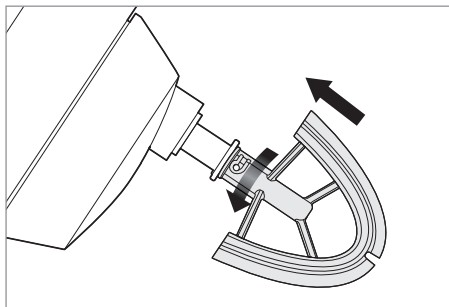

4. To remove, push upwards on the accessory towards the motor head and turn clockwise on the spindle until the groove and notch are aligned.
5. Pull downwards on the accessory to release from the motor spindle.

## ASSEMBLING THE SPLASH GUARD

Attach the splash guard to minimise splattering and splashing of ingredients while in operation. The splash guard also has a handy pouring spout so ingredients can be added while mixing.

1. To attach the splash guard, ensure the speed control dial is set to the OFF (0) position, the mixing bowl is securely locked into place and the mixer motor head is horizontal with the appropriate mixing accessory already in place.
2. Slide the splash guard over the mixing bowl so that it fits around the motor spindle with accessory. Once on the mixing bowl, slide the pouring spout into the grooves on the splash guard until it is securely in place.



3. The mixer is now ready to operate.



# Functions

## OPERATING THE MIXER

### Planetary Mixing Action

Planetary mixing action is similar to the mixing action used by commercial mixers in bakeries and patisseries with 360 degree beater-to-bowl coverage. This is achieved by the counter-clockwise motion of the mixer head combined with the clockwise sweep of the accessory. The result is thoroughly mixed ingredients without the need for a rotating bowl.

Attach the appropriate accessory for the mixing task required, using the following guide.

### The Scraper Beater

The double-sided scraper beater with its soft edges has been specifically designed to repeatedly scrape around the bowl during mixing, better incorporating ingredients throughout the entire mixture. It is the perfect accessory for creaming butter and sugar, mixing sticky ingredient or folding egg whites to make:

- Frosting and icing
- Cheesecakes
- Flavoured butters
- Muffin batters
- Creaming butter and sugar
- Light to medium cake batters

Additionally, due to the efficient mixing action of the Scraper Beater, the mixing time of many recipes may be reduced. Refer to the Scraper Beater table for approximate mixing times. These are a guide only. Longer mixing times may be required for larger quantities.

## SCRAPER BEATER TABLE

MIXTURE	MIXING TASK	APPROX. MIXING TIME
Butter & Sugar	Creaming	3–4 minutes (or until mixture is light and creamy)
Cake, biscuit & muffin batters	Incorporating wet and dry ingredients	30–40 seconds (or until all ingredients are combined)
Thin/light batters (i.e. Pancakes)	Incorporating wet and dry ingredients	20-30 seconds (or until batter is smooth)
Icing	Incorporating wet and dry ingredients	40–50 seconds (or until all icing is smooth)
Frosting	Creaming butter	1–2 minutes (or until butter is smooth and creamy)
	Combining icing sugar, butter & liquid ingredients	50–60 seconds (or until mixture is light and fluffy)

### The Wire Whisk

A vital accessory for incorporating air into mixtures to make them light and fluffy and is best suited for:

- Eggs
- Egg whites
- Cream
- Sponge, chiffon or angel food cakes
- Meringues and pavlovas
- Sauces and dressings

### The Dough Hook

A handy accessory that takes the hard work out of combining and kneading yeast-based dough to make:

- Breads
- Rolls
- Pizzas
- Focaccias
- Sweet buns

## SPEED GUIDE

SPEED	MIXER ATTACHMENT
1-4	Dough Hook
1-6	Scraper Beater
1-7	Wire Whisk

SPEED	MIXING SETTING	FOR
OFF	Mixer Not Operating	
1-4	Folding and Kneading	Recipes that require a LOW speed Combining dry ingredients Incorporating ingredients Pasta dough, Bread dough, Heavy batters
3-4	Light Mixing	Recipes that require a MEDIUM speed Cake batters, Biscuit dough Bread dough Pastry dough
4-5	Beating & Creaming	Recipes that require a HIGH speed Butter & sugar Eggs Icing
6-7	Whipping & Aerating	Recipes that require a HIGH speed Egg whites, Eggs, Meringue, Sponge cake, Cream



### NOTE

The above table is a guide only. Speed may need to be adjusted when operating based on the volume and density of ingredients used. If the mixer starts to shake or move during operation, reduce the speed.



### NOTE

If the speed control dial is on a setting other than OFF (O) when first turned on at the power outlet, the bench mixer will not start mixing, but will remain in a pause position until the speed dial is turned back to OFF (O), then turned to a speed setting.

1. Ensure the speed control dial is set to the OFF (O) position.
2. Using the tilt release button, tilt the mixer motor head into a diagonal position and lock into place.
3. Secure the mixing bowl into place on the mixer recess base.
4. Attach the required mixing accessory for the task.
5. If using the attachment hub, refer to the 'Using the Attachment Hub' section of this book for more details.
6. Place all ingredients into the mixing bowl as listed in the recipe.
7. Using the tilt release button, tilt the mixer motor head into a horizontal position and lock into place. Attach the splash guard, if desired.



### NOTE

If the attachment hub is not being used, ensure the hub cover remains securely in place before mixing begins.

8. Insert the power cord into a 230V or 240V power outlet and switch the power on at the power outlet. The mixer is ready to use in standby mode.
9. Commence mixing by turning the speed control dial in a clockwise direction to the setting outlined in the recipe. The light will illuminate with the corresponding setting, and the mixing will start automatically. Although the mixer is equipped with a controlled soft start, it is still recommended to start any mixing task on a lower speed to prevent splattering, then increase the speed as required.
10. If required, occasionally stop the mixer during operation and scrape any mixture on the sides of the mixing bowl with a spatula.



### NOTE

Turn the speed control dial to the OFF (O) position or press the speed control dial inward to PAUSE, then tilt the mixer motor head to the diagonal position if you need to scrape down the mixing bowl during use.

11. When mixing is complete, turn the speed control dial to the OFF (O) position, switch the mixer off at the power outlet and remove the power cord from the outlet.
12. Remove the mixing bowl and mixing accessory from the mixer body.



### **WARNING**

After mixing, remove the mixing accessory with care as it may be hot after use.

### **COUNT-UP TIMER**

The count-up timer is for gauging mixing time, making it easier to repeat the results.

The timer will automatically begin counting up as soon as the dial is turned to one of the speed settings.

When the dial is pushed to PAUSE, the current mixing time will flash on the until mixing is resumed or 5 minutes, whichever comes first. When the dial is turned to OFF (O), the timer display will reset back to 0:00.

The maximum count up time is 60 minutes. When the timer goes beyond 9:59, it counts in whole minutes. Turn the speed control dial back to the OFF (O) position to reset.

### **COUNT-DOWN TIMER**

The count-down timer is for any recipe that specifies the length of time ingredients should be mixed. The maximum count-down time is 60 minutes.

To set the count-down timer, press the up or down arrows until the desired mixing time is displayed on the timer display screen. Press and hold to scroll more quickly.

Rotate the speed control dial to select the desired speed and begin mixing. When the timer has finished counting down, it will beep, the mixer will automatically turn off and the timer will flash 'OFF'.

The control dial must be rotated to the OFF (O) position to reset the timer and to continue mixing.

### **CONTROLLED SOFT START**

This bench mixer is equipped with a controlled soft start feature, even when using PAUSE mode. The mixing action on any speed setting will start in a controlled manner before moving to the chosen speed.

It is still recommended to first start mixing on a lower speed, then increase the speed control dial when operating.

### **PRESS TO PAUSE - PRESSING THE SPEED CONTROL DIAL**

At any stage during mixing (either count-up or count-down), press the speed control dial inward once to pause. This will pause the mixer and hold the current time on the timer. The light on the timer will flash.

Add additional ingredients as needed. To continue operation, simply press inward on the control dial again. The timer will continue to count up or down, depending on the selection. Turn the dial to the OFF (O) position to reset the timer.

### **PAUSE MODE - TILTING UP THE MIXER HEAD**

The mixer will pause automatically whenever the mixer head is lifted. To resume mixing, place the motor head down within 5 minutes and move the dial up or down one speed and the mixer will continue operation, with the timer continuing to count up or down.

If the mixer head is lifted for over 5 minutes before returning to horizontal, the mixer will reset the timer to 0:00. Turn the speed control dial to the OFF (O) position to reset.

### **OVERLOAD PROTECTION SYSTEM**

The motor in this bench mixer is protected from burning out by a manual reset cut-out switch. If the bench mixer is overloaded or operated continuously for too long, the motor may overheat and stop.

Turn the speed control dial back to the OFF (O) position, switch the mixer off at the power outlet and unplug it.



Allow the mixer to cool for approximately 30 minutes. Once the motor is fully cooled, the overload protection device will reset. The mixer will be ready to use again when it powers back into standby mode. Do not operate the mixer continuously with an excessive load for more than 3 minutes. To reduce the risk of overloading, remove some of the mixture and process in smaller batches.

## USING THE ATTACHMENT HUB



### IMPORTANT

Attachments that require the use of the hub for this mixer are sold separately. Only attachments specifically designed for this mixer (Model LEM750) may be used.

Never use accessories and hub attachments (sold separately) other than those specifically designed or specified with this bench mixer.



### NOTE

Never operate any of the hub attachments whilst using the bench mixer accessories at the same time.

1. To remove the magnetic attachment hub cover, push on the bottom half of the cover so that the top half pops out, then remove and store safely.

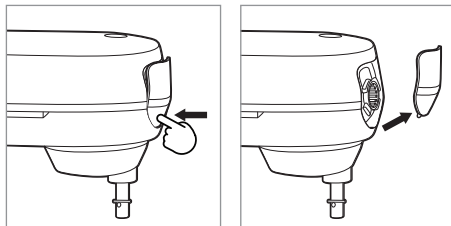

2. Ensure the chosen attachment is fully assembled before connecting to the attachment hub. Refer to the individual attachment instruction booklet for how to assemble and attach to the bench mixer attachment hub, as each hub attachment may be different.

3. Once the attachment is fully assembled on the attachment hub, refer to the individual hub attachment instruction booklet for food preparation, functions and operation. Turn the speed control dial to the appropriate setting, based on the attachment used, or found in the table titled 'Hub Attachments' following:

### Hub Attachments

COMPATIBLE ATTACHMENTS	Speed/Setting on Control Dial
LEM012 - the Pasta Chef™ Roller Attachment	1-4
LEM013 - the Spiralizer Chef™ Attachment	1-4
LEM014 - the Food Processor Chef™ Attachment	1-4
LEM016 - the Grinder Chef™ Attachment	1-4



### WARNING

Do not operate the hub attachments exceeding speed 4 to avoid vigorous vibration during operation, injury or damage to the appliance.



### NOTE

After use, always remove the hub attachment, clean and store separately.

4. Once the task is complete, turn the speed control dial to the OFF (0) position. Press the hub attachment release button to remove the attachment from the mixer hub.
5. Refer to the individual attachment instruction booklet for information on assembling, disassembling, the attachment, care, cleaning and storage.
6. Replace the attachment hub cover by aligning the bottom grooves of the attachment hub cover with the bottom of the attachment hub and lightly push the cover in. The magnetic pull will secure the attachment cover in place.

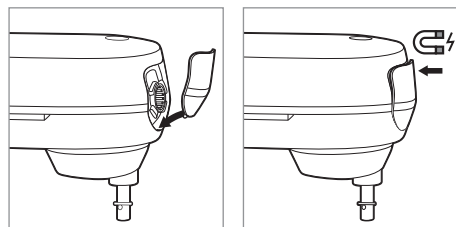



## Care, Cleaning & Storage

Before cleaning, ensure that the speed control dial is in the OFF (0) position, the power is switched off and power cord is removed from the power outlet.

Ensure the mixing bowl, splash guard, mixing accessories and attachments (if used) have all been removed from the mixer body.

### MIXER BODY

1. Wipe clean with a soft, damp cloth then dry thoroughly. Wipe any excess food particles from the power cord.
2. Do not allow any water or other liquids to enter the gear system as this may cause damage.



### WARNING

Never immerse the mixer, power cord or power plug in water or any other liquids.

3. Avoid using any abrasive scouring pads or cleaners when cleaning any part of the mixer as these may cause damage to the surface of these parts.

### MIXING BOWL

1. Wash the bowl with warm, soapy water using a soft cloth or soft bristle brush. Rinse and dry thoroughly.
2. The mixing bowl can be washed in the dishwasher on a standard wash cycle.
3. Do not soak the mixing bowl in water for extended periods of time as this may damage the metal finish.

### MIXING ACCESSORIES AND SPLASH GUARD

1. Wash the accessory used and splash guard with warm soapy water using a soft cloth or soft bristle brush. Rinse and dry thoroughly.
2. Do not place any of the accessories or the splash guard into the dishwasher. The heat may cause damage to these parts.

### HUB ATTACHMENTS

As each attachment hub attachment is different, refer to the specific hub attachment instruction booklet for care, cleaning and storage details.

### STORAGE

1. Store your mixer on the kitchen bench or standing upright in an accessible cupboard.
2. Always ensure that the speed control dial is in the OFF (0) position and the mixer is unplugged from a power outlet when storing.
3. Using the cord storage feature, push the power cord into the cord storage compartment until just the Breville assist plug is showing.
4. Store the mixing bowl in the locked position in the bowl recess with all accessories inside the bowl and with the mixer motor head locked in the horizontal position. Store any hub attachments in their original box when not in use. Always remove any hub attachment from the mixer after use.



## Tips

### TIPS FOR BETTER BREAD MAKING

- Check the ingredients and read the recipe before starting to bake.
- Measure ingredients accurately. Weighing is more accurate than measuring by volume. To accurately measure water please note that 1ml water = 1g.
- Don't use hot water or liquids as this can kill the yeast. Water and liquids should be added at a tepid temperature.
- Don't use self-raising flour to make yeasted bread unless recipe states otherwise.
- If the weather is hot and humid, reduce the yeast by ¼ teaspoon to avoid over rising of the dough.
- Flour properties can alter on a seasonal or storage basis, so it may be necessary to adjust the water and flour ratio. If the dough is too sticky, add extra flour 1 tablespoon at a time if the dough is too dry, add extra water 1 teaspoon at a time. A few minutes is needed for these extra ingredients to be absorbed. Dough with the correct amount of flour and water should form into a smooth, round ball that is damp to the touch but not sticky.

### Warm area for rising

- Yeast, either when sponging or in the dough, requires warmth to rise. To create a 'warm area' for dough to rise, place baking tray over a bowl of fairly warm water, place prepared dough item on baking tray, cover loosely with lightly greased thicker-style plastic wrap or a tea towel. Ensure kitchen is warm and free of draughts. Allow the dough to rise until doubled in size.

### VITAL INGREDIENTS FOR BREAD MAKING

Flour is the most important ingredient used for bread making. It provides food for the yeast and gives structure to the loaf. When mixed with liquid, the protein in the flour starts to form gluten. Gluten is a network of elastic strands that interlock to trap the gases produced by yeast. This process increases as the dough continues kneading and provides the structure required to produce the weight and shape of the baked bread.

**White wheat flour** sold as baker's bread flour or plain flour may be used. Plain flour is most readily available; however, best results are obtained with flour at least 11% protein content.

**Wholemeal wheat flour** contains the bran, germ and flour of the wheat grain. Although breads baked with this type of flour will be higher in fibre, the loaf may be heavier in texture. Lighter textured bread can be achieved by replacing 160g of wholemeal flour with white bread flour.

**Rye flour** popular for bread making, is low in protein so it is essential to combine rye flour with bread flour to make the bread rise successfully.

**Gluten flour** is made by extracting the gluten portion from the wheat grain. Adding gluten flour can improve the structure and quality of bread when using low-protein, plain, stone ground and wholemeal flour.

**Bread mixes** contain flour, sugar, milk, salt, oil and other ingredients such as bread improver. Usually only the addition of water and yeast is required.

**Bread improvers** are available in supermarkets. The ingredients in a bread improver are usually a food acid such as ascorbic acid (Vitamin C) and other enzymes (amylases) extracted from wheat flours. Adding a bread improver will help strengthen the dough resulting in a loaf that is higher in volume, softer in texture, more stable and has improved shelf life qualities.

**Sugar** provides sweetness and flavour, browns the crust and produces food for the yeast. White sugar, brown sugar, honey and golden syrup are all suitable to use. When using honey or golden syrup it must be counted as additional liquid.

**Powdered milk** and milk products enhance the flavour and increase the nutritional value of bread. Powdered milk is convenient and easy to use.

**Salt** is an important ingredient in bread making. In the dough, salt increases water absorption, improves kneading, strengthens the gluten development and controls fermentation of the yeast which results in improved loaf shape, crumb structure, crust colour, flavour and keeping qualities. As salt inhibits the rising of bread be accurate when measuring.

**Fat** adds flavour and retains the moisture. Vegetable oils such as sunflower, canola, etc. can be used. Butter or margarine can be substituted for oil in recipes but may give a yellow coloured crumb.

**Yeast** is used as the raising agent for the breads and requires liquid, sugar and warmth to grow and rise. Before using dried yeast always check the use by date, as stale yeast will prevent the bread from rising.

**Water** If using water in cold climates or from the refrigerator, allow water to come to room temperature. Extremes of hot or cold water will prevent the yeast activating.

**Eggs** can be used in some bread recipes and provide liquid, aid rising and increase the nutritional value of the bread. They add flavour and softness to the crumb and are usually used in sweeter types of bread.

**Other ingredients** such as fruit, nuts, chocolate chips, etc., required to remain whole in the baked bread, should be suspended in the dough. These ingredients should be gradually added during the kneading and before the dough rises for the first time.

## TIPS FOR BETTER CAKE & PASTRY MAKING

- Check the ingredients and read the recipe before starting to bake.
- Measure ingredients accurately. Weighing is more accurate than measuring by volume.
- Preheat oven before starting recipe preparation, this will ensure the correct temperature is achieved before baking starts.
- Temperature and cooking times may vary with some ovens so adjust accordingly. If using a fan forced oven, reduce the temperatures in the recipes by 10–20°C.
- When mixing, start the mixer at a lower speed then gradually increase to the recommended speed in the recipe especially when adding dry ingredients.
- When using smaller quantities turn off the mixer from time to time and scrape the bowl with a spatula.
- Ensure beaters and mixing bowl are clean, dry and free of fats when whipping egg whites as these will impede aeration.
- Lightly grease trays and cake pans with melted butter, oil or an oil spray and line with non-stick baking paper; this will make removing your baked goods easier.
- Butter should be softened to room temperature to make creaming butter and sugar easier.
- Keep surfaces and ingredients chilled when making, handling or rolling out pastry. Butter for pastry making should be kept refrigerated.
- Avoid stretching pastry when rolling out as it will shrink when baking. Use light, even strokes in one direction and avoid pressing down hard on the rolling pin. Where possible, rest pastry in the refrigerator before baking.
- Eggs and egg whites should be at room temperature. Adding room temperature eggs to cake mixes will also prevent curdling of the butter mixture.
- Separate eggs individually into another container before adding to other ingredients to avoid potential spoilage.

- Separate egg whites carefully to avoid inclusion of egg yolks. Egg yolks contain fat and will prevent successful whipping of egg whites.
- Rinse beaten egg residue from beater and mixing bowl or other utensils with cold water immediately after use. Using hot water will set the egg and make cleaning difficult.
- Test if cakes are cooked 5 minutes before end of recommended cooking time by inserting a metal or wooden skewer into the centre of the cake. The skewer should come out clean or with small dry crumbs on it.
- For crisper results when baking biscuits, remove the baking trays from the oven and place directly onto wire racks. Move the biscuits slightly away from their baked position on the trays and cool completely before removing.

## VITAL INGREDIENTS FOR CAKE & PASTRY MAKING

**Flour** such as plain, self-raising and wholemeal, used for cake and pastry making should be lower in protein (gluten) than flour used for bread making.

**Plain flour** has a lower protein (gluten) content than bread flour, and gives baked products, such as cakes, muffins, pastries, scones and pancakes, a softer texture.

**Self-raising flour** is a blend of plain flour and raising agents such as baking powder. Self-raising flour can be used in recipes to replace plain flour and baking powder. To make 1 cup self-raising flour sift together 1 cup plain flour and 2 teaspoons baking powder.

**Wholemeal flour** contains more parts of the whole wheat grain – flour, bran and wheat germ – and can be used in muffins, breads and pie cases but will have a denser texture.

**Cornflour** is traditionally made from maize (corn) and is used in some baked products to give a finer texture and can also be used as a starch to thicken sauces and desserts.

**Rice flour** is derived from rice and is used to give a finer texture in baked products such as shortbread biscuits.

**Baking powder** is a mixture of cream of tartar and bicarbonate of soda and is used as a raising agent in baking.

**Bicarbonate of soda**, also known as baking soda, is an ingredient in baking powder and can be used as an additional raising agent .

**Butter** will give particular flavour and soft texture to baked products. Margarine can replace butter to give a similar result. Oil can be used in some baking to replace butter but will give texture and flavour differences. If using oil, use a light flavoured oil like vegetable, sunflower or grapeseed oil. Using stronger flavoured oils, like nut and olive oils, will affect the flavour of the cake.

**Eggs** should be at room temperature to give better volume when making cakes and sponges.

**Milk** should be full cream unless specified. Light, low fat or skim milk can be used but will give texture and flavour differences.

**Sugar** (white crystal sugar) is used to give flavour, texture and colour to baked products.

**Caster sugar** is often used in baking as it is easier to dissolve when creaming butter and sugar.

**Brown sugar** is also easy to dissolve and can be used to give a different flavour and texture.

The large crystals of raw sugar are slower to dissolve and can be suitable for baked products such as muffins.

## MEASURING & WEIGHING

The accuracy of measurements can affect the critical balance of the recipe. Use accurate and appropriate measuring equipment to ensure the best results.

### Dry measuring cups & spoons

For dry ingredients, use nested plastic or metal dry measuring cups and spoons. Do not use tableware cups or spoons.

It is important to spoon or scoop the dry ingredients loosely into the cup. Do not tap the cup or pack the ingredients into the cup unless otherwise directed (e.g. packed brown sugar).

The extra amount gained from packing or tapping down ingredients can affect the critical balance of your recipe. Level the top of the cup by sweeping the excess with the back of a knife.

When using measuring spoons for either liquid or dry ingredients such as yeast, sugar, salt, dry milk or honey, measurements should be level, not heaped.

### Liquid measuring cups

For liquid ingredients, use transparent plastic or glass liquid measuring cups with the measurements marked clearly on the side.

Measuring cup must be on a flat and horizontal surface. An inaccurate measurement can affect the critical balance of the recipe.

### Units of measurement

Some units of measurement are different in different countries. Please consider the guide below if using recipes, or equipment, from international sources.

#### Cups

250ml for Australia & New Zealand

#### Tablespoons

20ml for Australia

15ml for New Zealand

#### Teaspoons

5ml



## Troubleshooting

---

### PROBLEM

### EASY SOLUTION

---

Mixer will not work when switched ON

- Check the power cord is correctly plugged into the outlet and the outlet is on.
- Always ensure the speed control dial is in the OFF (0) position before starting.
- Ensure the motor head is locked into a horizontal position.
- Ensure the Pause feature has not been engaged.
- The temperature overload protection (manual reset cut-out switch ) device has not fully reset; allow more time for the motor to cool down.

---

Cannot set the time on the count-down timer

- Always ensure the speed control dial is in the OFF (0) position before trying to set the count-down time.

---

Mixer suddenly switches off during mixing

- The mixer has been stressed by overloading or stalling. The mixer will automatically activate the overload protection and the unit will switch off. The "E1", "E2" or "E3" error message is flashing on the timer display. If this happens, turn the speed control dial back to the OFF (0) position. Turn the mixer off at the power outlet and unplug it for at least 30 minutes. The overload protection device will reset, and the mixer will be ready to use again when it powers back into standby mode.

---

Noise is heard when scraper beater is mixing.

- When ingredients are in the mixing bowl, the scraper beater may make a slight noise as it scrapes the sides and bottom of the bowl. This is normal and should not cause concern. Do not turn the mixer on with the scraper beater in place if the mixing bowl is empty. This will cause the scraper beater to make a loud noise as it scrapes the bowl.
-



## Dough Hook Recipe

### *Cheese and bacon BBQ rolls*

⌚ Preparation time - 1 hour 30 minutes

⌚ Cooking time - 30 minutes

🍞 Makes 6 rolls

---

#### Ingredients

375ml warm water

60ml olive oil

1 tsp. caster sugar

1 tsp. salt

600g bread flour

2 tsp. dried yeast

3 tbsp. barbeque sauce

1 cup diced bacon

1 cup grated tasty cheese

---

#### Method

1. Place the water, olive oil, sugar, salt, flour and yeast into the mixing bowl of the bench mixer with the dough hook attached.
2. Turn the speed control dial to speed 1 and mix for 30 seconds until the ingredients are combined. Increase to speed 4 and knead for 4 minutes.
3. Shape the dough into a ball, return the ball to the mixing bowl, cover with cling wrap and place in a warm, draught free place to rise for 1 hour or until the dough has doubled in size.
4. Pre-heat a fan-forced oven to 180°C and line a baking tray with baking paper.
5. Place the mixing bowl back onto the bench mixer with the dough hook attached and knead on speed 1 for 2 minutes.
6. Divide the dough into 6 and roll into balls. Place the 6 balls onto the lined baking tray about 5cm apart and allow the dough balls to rest for 20 minutes.
7. Generously brush each ball with the barbeque sauce and top each of the balls with the bacon and cheese.
8. Place into the oven and bake for 20 minutes.





# Scraper Beater Recipe

## *Peach and strawberry crumble tray cake*

🕒 Preparation time - 30 minutes

🕒 Cooking time - 30 minutes

🍴 Makes one 20x30cm cake

---

### Ingredients

#### Crumble top

½ cup plain flour  
½ cup light brown sugar  
¼ tsp. cinnamon  
Pinch salt  
¼ cup almond meal  
¼ cup desiccated coconut  
75g butter cold  
½ cup oats

#### Cake

125g unsalted butter, room temperature  
¾ cup caster sugar  
3 eggs  
1 tsp. vanilla paste  
½ cup milk  
2 cups self-raising flour  
2 large strawberries, sliced  
100g tinned peach slices

---

### Method

#### Crumble top

1. Place the flour, brown sugar, cinnamon, salt, almond meal, coconut and butter into a food processor and process until the ingredients are combined. Remove the mixture from the food processor and stir the oats through. Put aside until ready.

#### Cake

2. Pre-heat a fan-forced oven to 175°C and line a 20cm x 30cm deep baking tray with baking paper.
3. Place the butter and sugar into the mixing bowl of the bench mixer with the scraper beater attached.
4. Turn the speed control dial to speed 1 and mix until the ingredients are combined. Increase to speed 6 and beat for 3 minutes. Reduce to speed 3 and add the eggs one at a time, beating well between each addition.
5. Reduce to speed 1 and add the milk and flour alternately.
6. Place the cake batter into the prepared baking tray and scatter the strawberries and peach slices evenly over the top.
7. Sprinkle the crumble topping evenly over the top and place into the oven and bake for 30 minutes or until a skewer comes out clean when inserted into the centre of the cake. Allow to cool slightly before serving warm or cool.



Notes



Notes

## Breville Customer Service Centre

### **Australian Customers**

**Phone:** 1300 139 798

**Web:** [www.breville.com](http://www.breville.com)

### **New Zealand Customers**

**Phone:** 0800 273 845

**Web:** [www.breville.com](http://www.breville.com)

# **Breville®**

**Master Every Moment™**

Breville, the Breville logo, Master Every Moment, and Bakery Chef are trademarks of Breville Pty. Ltd. A.B.N. 98 000 092 928.

Copyright Breville Pty. Ltd. 2020.

Due to continued product improvement, the products illustrated/photographed in this brochure may vary slightly from the actual product.

LEM750 ANZ – B20